

Chemie-Normpumpen CPKO
Standardized Chemical Pumps CPKO
Pompes normalisées pour produits chimiques CPKO
Bombas químicas estandarizadas CPKO

50 Hz

Die in den Kennlinienblättern angegebenen NPSH-Werte sind Meßwerte, die einem Förderhöhenabfall von 3% entsprechen. NPSH-Wert im Teillastgebiet:

NPSH-Werte für Förderströme kleiner als $Q = 0,3 \times Q_{opt}$ können nur mit sehr hohem Aufwand gemessen werden. Der Nachweis von NPSH-Werten in diesem Förderstrombereich kann nicht akzeptiert werden.

Die Förderhöhen und Leistungsangaben gelten für Fördermedien mit einer Dichte $\rho = 1,0 \text{ kg/dm}^3$ und einer kinematischen Viskosität ν bis max. $20 \text{ mm}^2/\text{s}$.

Ist die Dichte $\neq 1,0$, muß die Leistungsangabe mit ρ multipliziert werden.

Förderstrom bei Ausführung mit Gleitringdichtung:

Bei der Ausführung mit einfachwirkender Gleitringdichtung und Produktzirkulation (Zirkulationsleitung vom Druckstutzen über die Dichtung und innere Zirkulation) ist beim Nenn-Förderstrom bis zu $20 \text{ m}^3/\text{h}$ ein Zirkulationsstrom von $1 \text{ m}^3/\text{h}$ hinzuzurechnen.

Beispiel: Gewünscht $Q = 15 \text{ m}^3/\text{h}$;

sämtliche Werte sind bei $15 + 1 = 16 \text{ m}^3/\text{h}$ abzulesen.

Diese Drucksache ist unser Eigentum. Sie darf weder vervielfältigt, noch Dritten zugänglich gemacht werden. Zuwiderhandlung verpflichtet zu Schadenersatz.

The NPSH values given in the performance curve sheets are measured values which correspond to a loss of discharge head of 3%.

NPSH values at part-load operation:

NPSH values for capacities below $Q = 0,3 \times Q_{optimum}$ can only be measured at considerable expense. The acceptance testing of NPSH values in this range cannot be undertaken.

The total heads and the performance characteristics refer to mediums compressed with $\rho = 1,0 \text{ kg/dm}^3$ and a kinematic viscosity ν up to $20 \text{ mm}^2/\text{s}$.

If the density amounts to $\neq 1,0$, the performance characteristics are to be multiplied by ρ .

Capacity for variant with mechanical seal:

For variants with single-acting mechanical seal and product circulation (circulation line from discharge nozzle via seal and internal circulation) a circulation flow of $1 \text{ m}^3/\text{h}$ must be added to any rated flow up to $20 \text{ m}^3/\text{h}$.

Example: desired capacity $Q = 15 \text{ m}^3/\text{h}$;

all readings must be taken at $15 + 1 = 16 \text{ m}^3/\text{h}$.

This document remains our property. It must neither be reproduced nor shown or ceded to third parties. Any infringement renders the offending party liable to damages.

Les valeurs de NPSH indiquées par les feuilles de courbes sont des valeurs mesurées correspondant à une perte de la hauteur d'élévation de 3%.

Valeurs du NPSH en charge partielle:

Pour des débits inférieurs au 0,3 du débit optimal, la mesure du NPSH entraîne des frais considérables. C'est la raison pour laquelle nous ne pouvons, pour ce qui concerne cette zone de débits, accepter la vérification des valeurs du NPSH.

Les caractéristiques pompe indiquées sont valables pour un milieu pompé d'une masse volumique égale à 1 et pour une viscosité cinématique n'excédant pas $20 \text{ mm}^2/\text{s}$. Si la masse volumique du milieu pompé a une valeur différente de 1, multiplier par cette valeur les caractéristiques indiquées.

Débit dans la version avec garniture mécanique:

Dans la version avec garniture mécanique à effet simple et circulation du produit (conduite de circulation à partir de la tubulure de refoulement via le joint d'étanchéité et circulation interne) il faut ajouter un flux de circulation de $1 \text{ m}^3/\text{h}$ au débit nominal jusqu'à $20 \text{ m}^3/\text{h}$ maxi.

Exemple: Q requis = $15 \text{ m}^3/\text{h}$; toutes les valeurs doivent être prises à $15 + 1 = 16 \text{ m}^3/\text{h}$.

Ce document est notre propriété. Il ne peut être ni reproduit, ni communiqué à des tiers. Nos droits à dommages résulteraient de la non-observation de ces dispositions.

Ce document est notre propriété. Il ne peut être ni reproduit, ni communiqué à des tiers. Nos droits à dommages résulteraient de la non-observation de ces dispositions.

Los valores NPSH indicados en las hojas de curvas características son valores de medición, que corresponden a un descenso de la altura de elevación de 3%.

Valores NPSH trabajando la bomba en carga parcial:

Los valores NPSH para caudales menores de $Q = 0,3 \times Q_{optimo}$ pueden ser medidos solamente con grandes dificultades. Las pruebas del NPSH en este sector de caudales no pueden aceptarse.

Las alturas de elevación y la indicaciones sobre potencias requeridas rigen para líquidos a impulsar con una densidad de $\rho = 1,0 \text{ kg/dm}^3$ y una viscosidad cinemática y hasta un máximo de $20 \text{ mm}^2/\text{s}$. Si la densidad $\neq 1,0$ debe multiplicar la potencia por ρ .

El caudal en la versión con cierre mecánico:

En la versión con cierre mecánico de efecto simple y una circulación a partir de la brida de impulsión a través de la junta y la circulación interna) hay que sumar un flujo de circulación de $1 \text{ m}^3/\text{h}$ al caudal nominal de hasta $20 \text{ m}^3/\text{h}$.

Ejemplo: Q requerido = $15 \text{ m}^3/\text{h}$; todos los valores deben desprenderse de $15 * 1 = 16 \text{ m}^3/\text{h}$.

Este impreso es de nuestra propiedad, no podrá reproducirse ni cederse a terceros. Las contravenciones se sancionan con pago de indemnizaciones por daños y perjuicios.

Kennfelder/Selection Charts/Diagrammes/Diagrama de conjunto

n = 2900 1/min

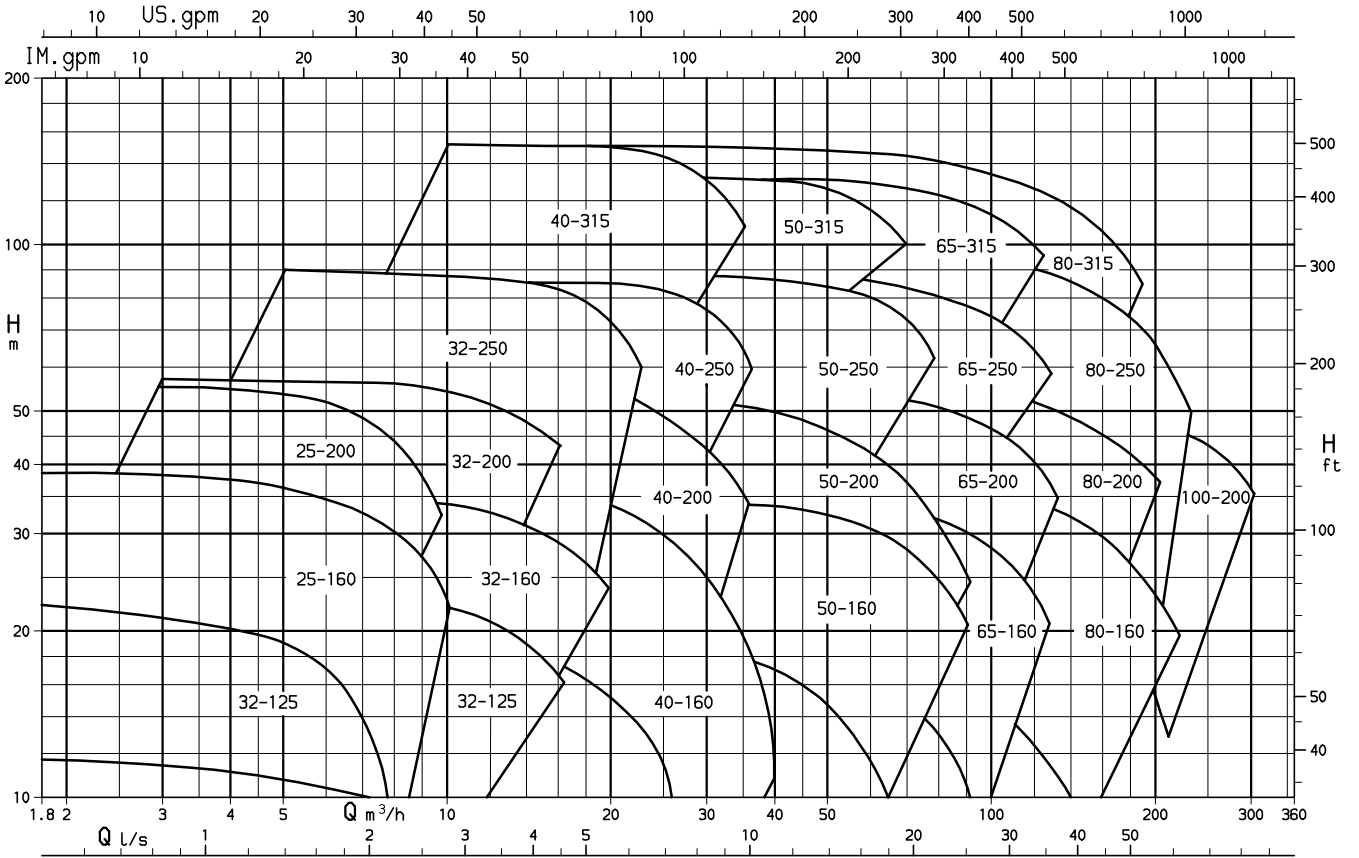

2736.4052

n = 1450 1/min

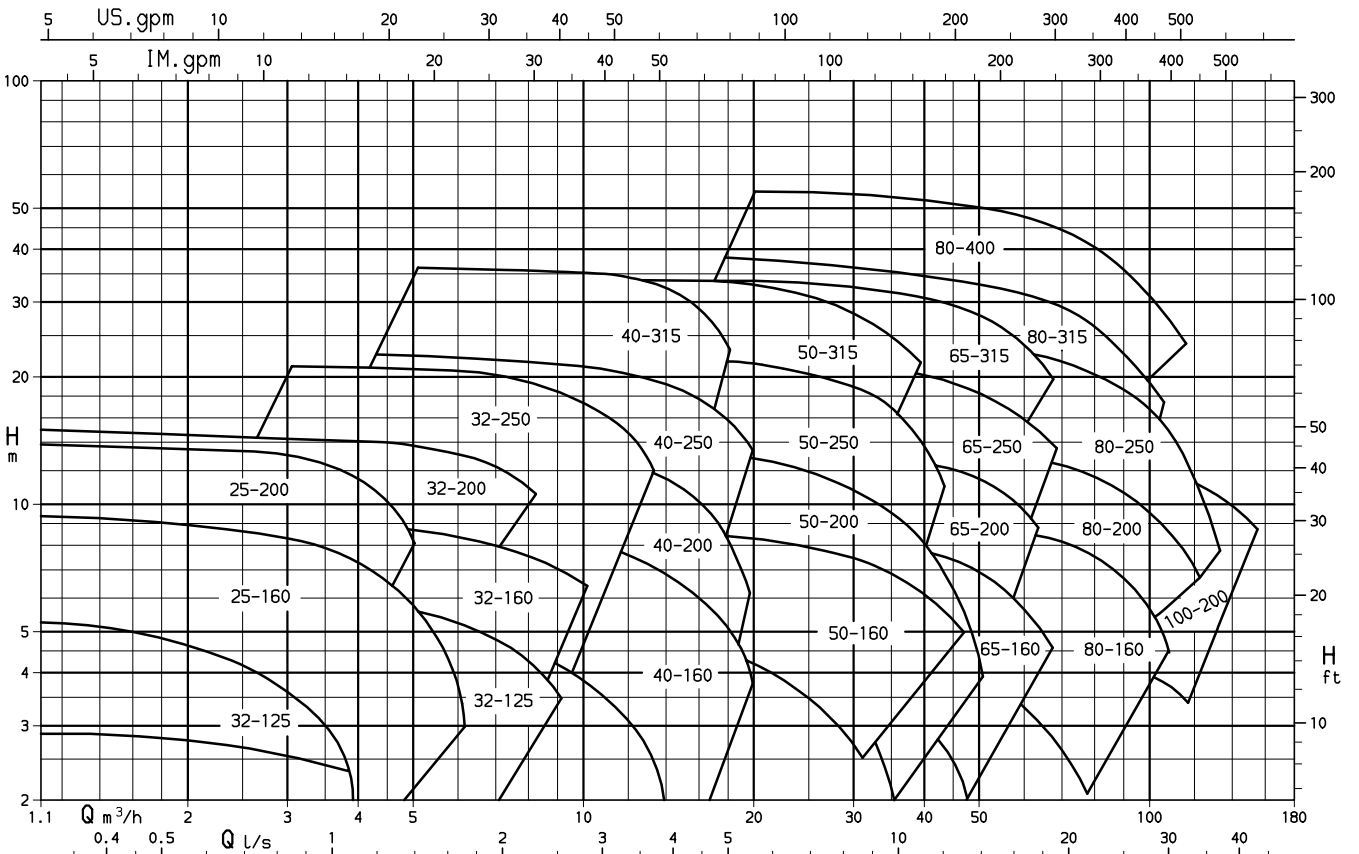

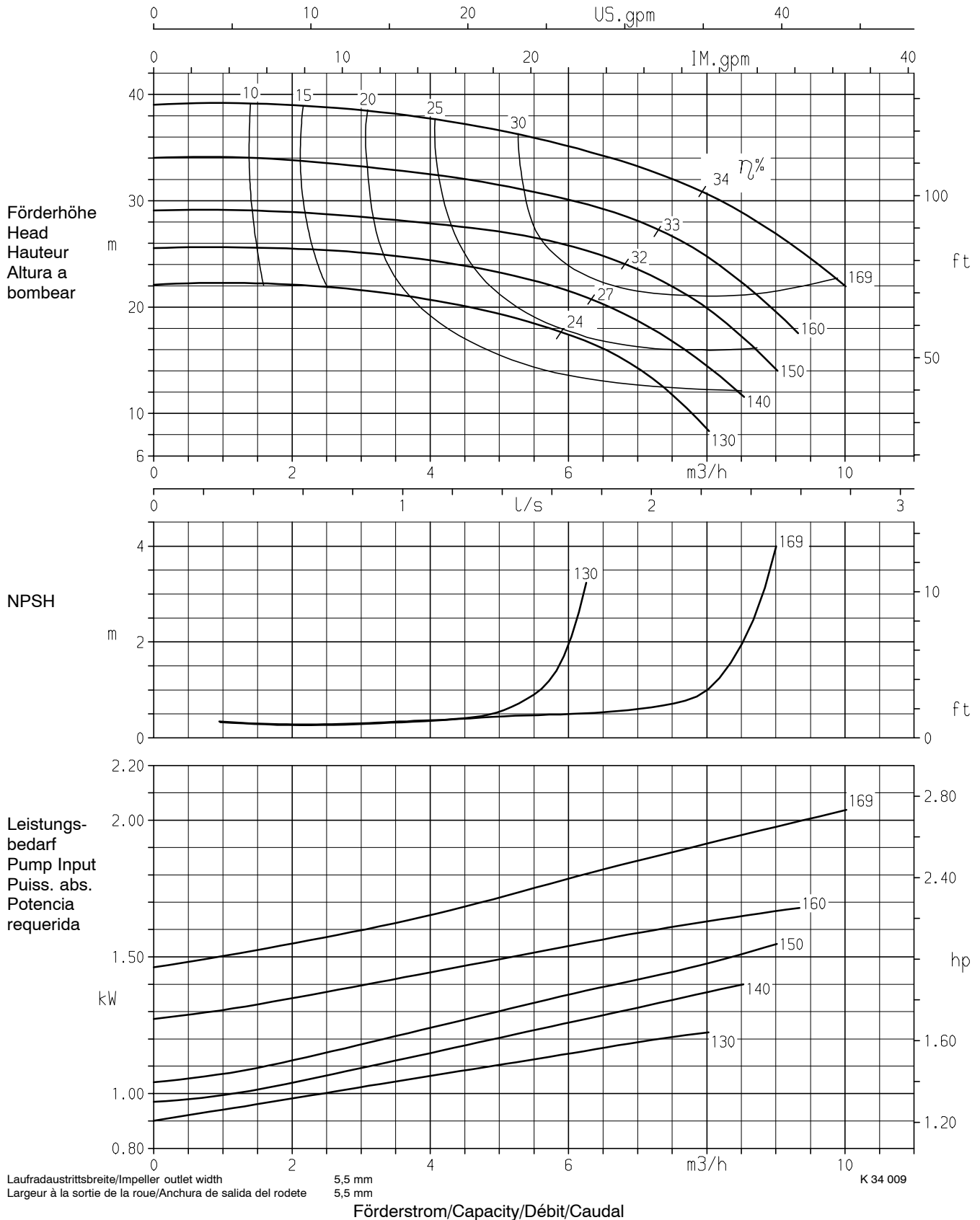

2736.4054

Baureihe Pump type	Modèle Tipo	Nenn Drehzahl Nom. speed	Vitesse nom. Revoluciones nom.	 KSB KSB Aktiengesellschaft Industrie- und Wassertechnik Postfach 1361, 91253 Pegnitz Bahnhofplatz 1, 91257 Pegnitz
CPKO	25-160	2900 1/min		
Angebots-Nr. Project No.	No. de l'offre Oferta-No.	Pos.-Nr. Item No.	No. de pos. No. de pos.	

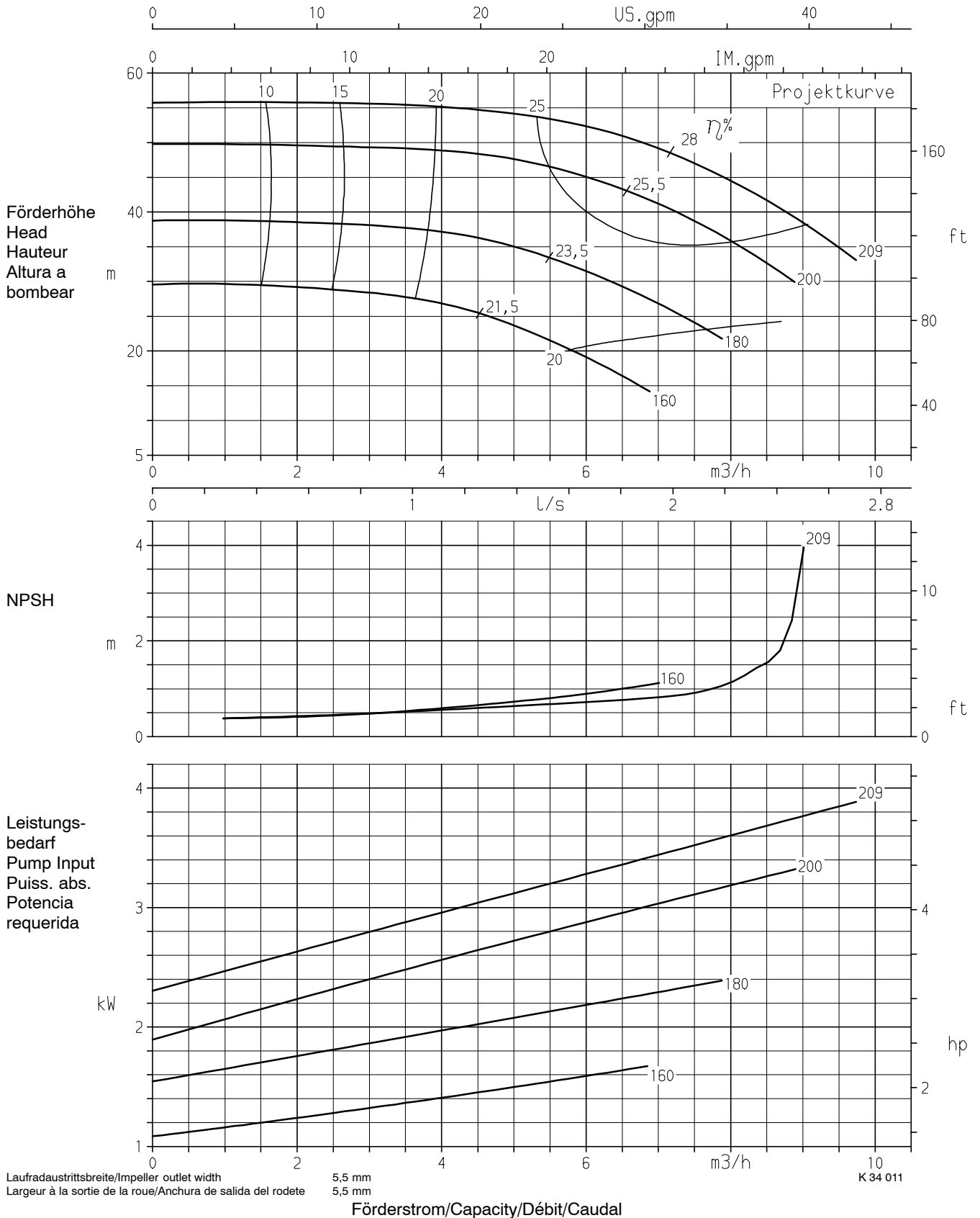

Baureihe Pump type	Modèle Tipo	Nenn Drehzahl Nom. speed	Vitesse nom. Revoluciones nom.	 KSB KSB Aktiengesellschaft Industrie- und Wassertechnik Postfach 1361, 91253 Pegnitz Bahnhofplatz 1, 91257 Pegnitz
CPKO	25-200	2900 1/min		
Angebots-Nr. Project No.	No. de l'offre Oferta-No.	Pos.-Nr. Item No.	No. de pos. No. de pos.	



Baureihe Pump type	Modèle Tipo	Nenn Drehzahl Nom. speed	Vitesse nom. Revoluciones nom.	 KSB KSB Aktiengesellschaft Industrie- und Wassertechnik Postfach 1361, 91253 Pegnitz Bahnhofplatz 1, 91257 Pegnitz
CPKO	32-125	2900 1/min		
Angebots-Nr. Project No.	No. de l'offre Oferta-No.	Pos.-Nr. Item No.	No. de pos. No. de pos.	

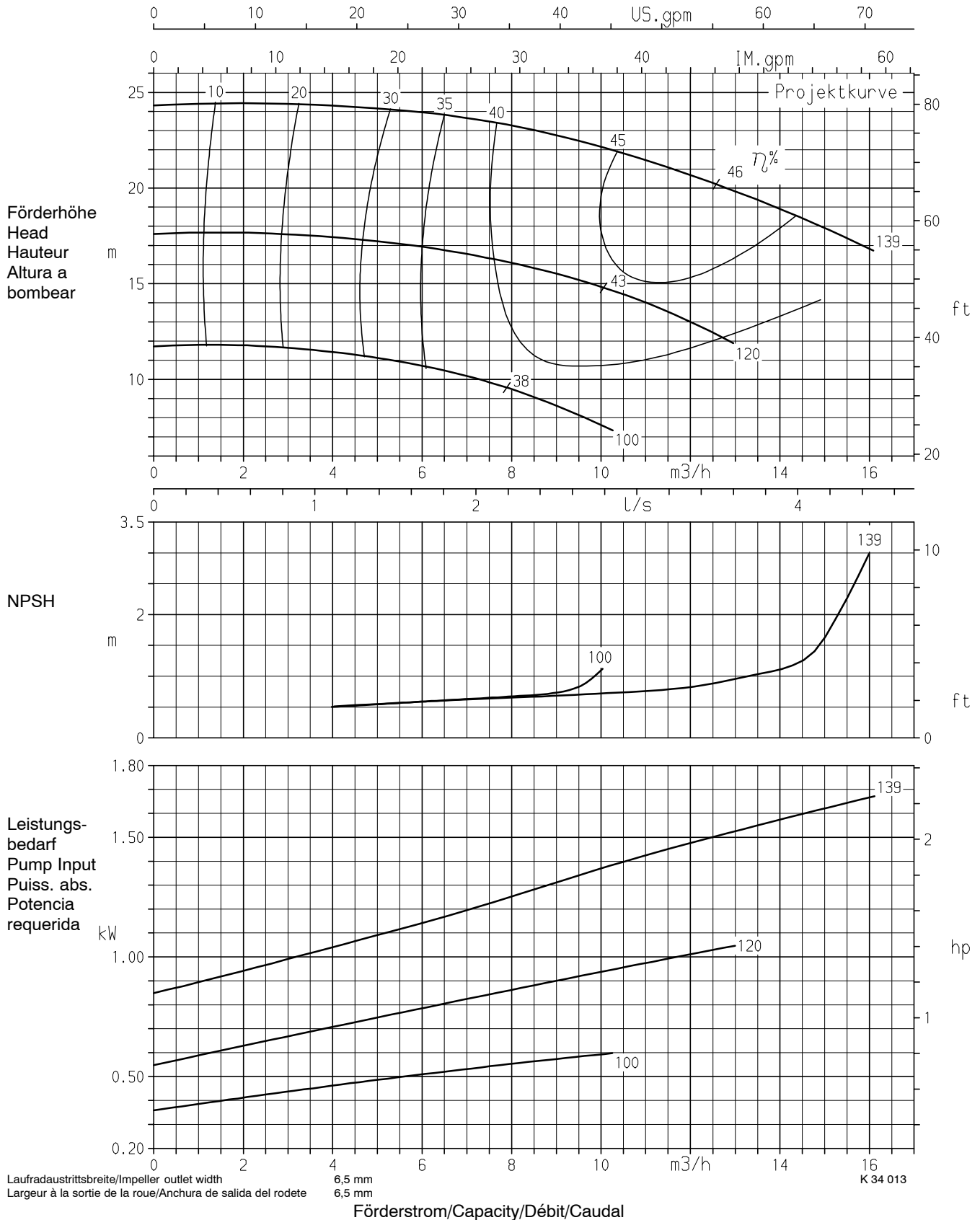

Baureihe Pump type	Modèle Tipo	Nennzahl Nom. speed	Vitesse nom. Revoluciones nom.	 KSB
CPKO	32-160	2900 1/min		
Angebots-Nr. Project No.	No. de l'offre Oferta-No.	Pos.-Nr. Item No.	No. de pos. No. de pos.	KSB Aktiengesellschaft Industrie- und Wassertechnik Postfach 1361, 91253 Pegnitz Bahnhofplatz 1, 91257 Pegnitz

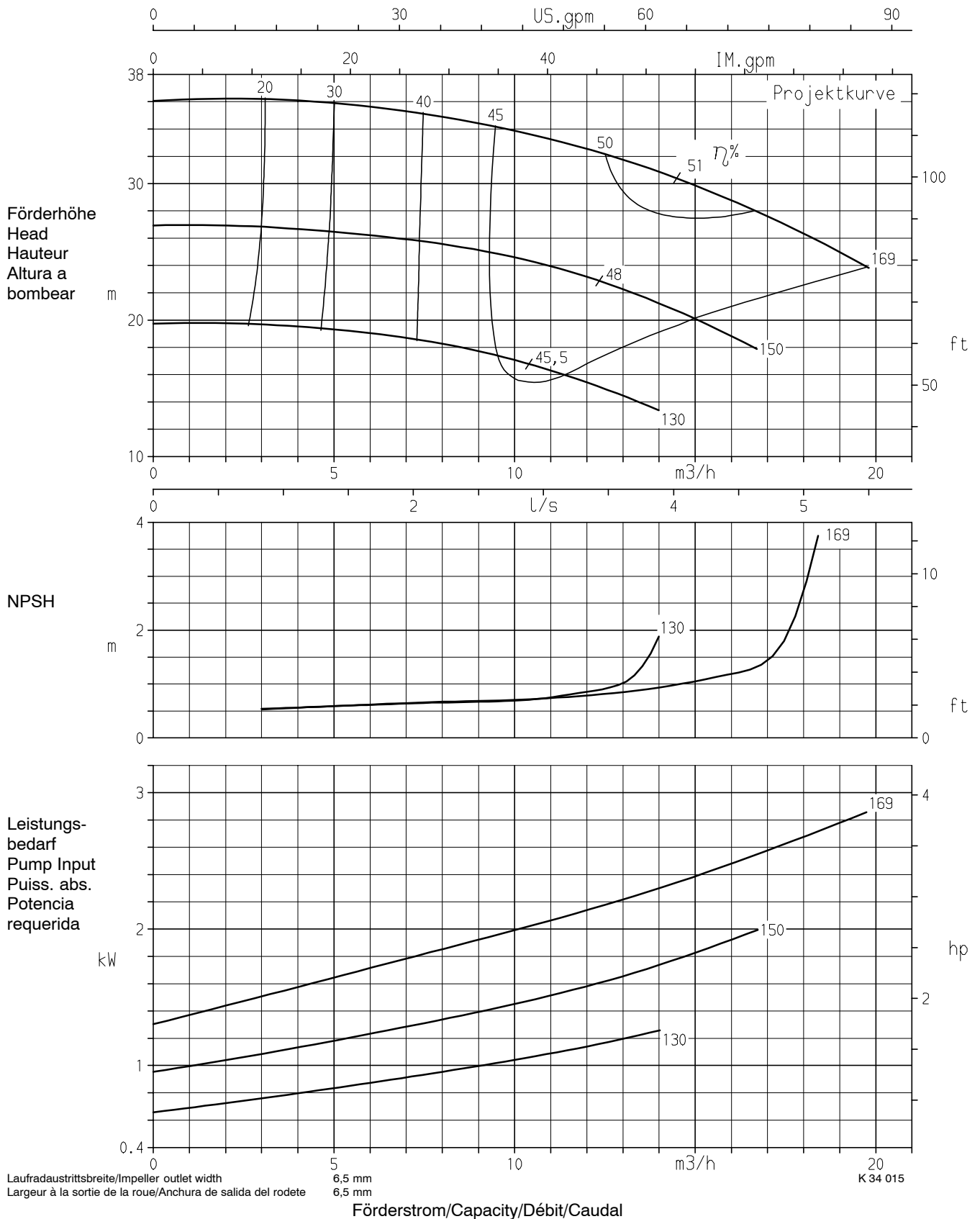

Baureihe Pump type	Modèle Tipo	Nenn Drehzahl Nom. speed	Vitesse nom. Revoluciones nom.	 KSB
CPKO	32-200	2900 1/min		
Angebots-Nr. Project No.	No. de l'offre Oferta-No.	Pos.-Nr. Item No.	No. de pos. No. de pos.	KSB Aktiengesellschaft Industrie- und Wassertechnik Postfach 1361, 91253 Pegnitz Bahnhofplatz 1, 91257 Pegnitz

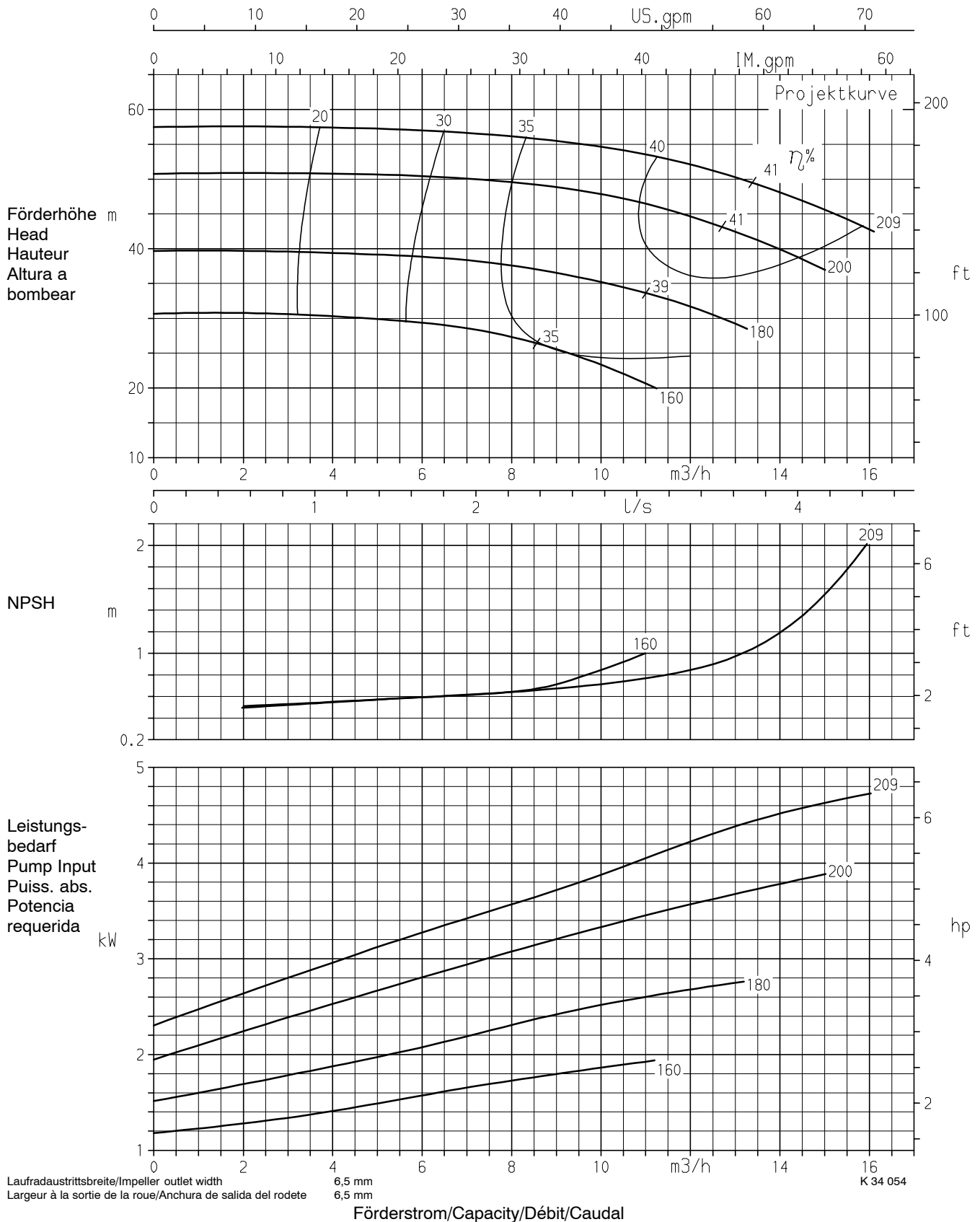

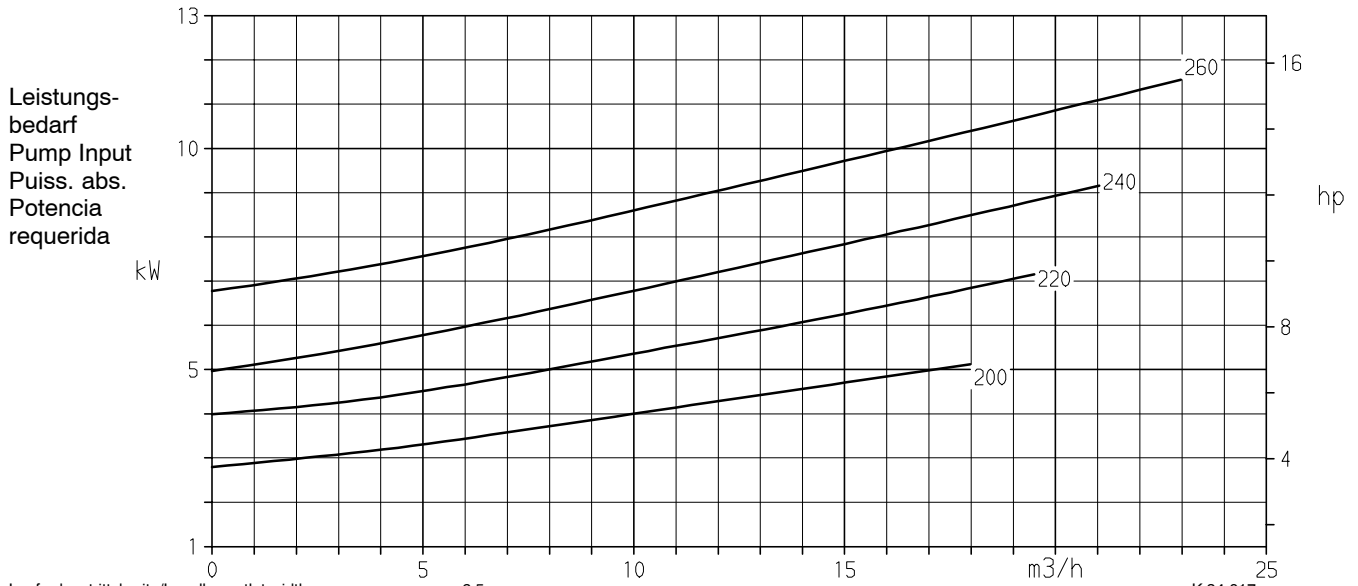
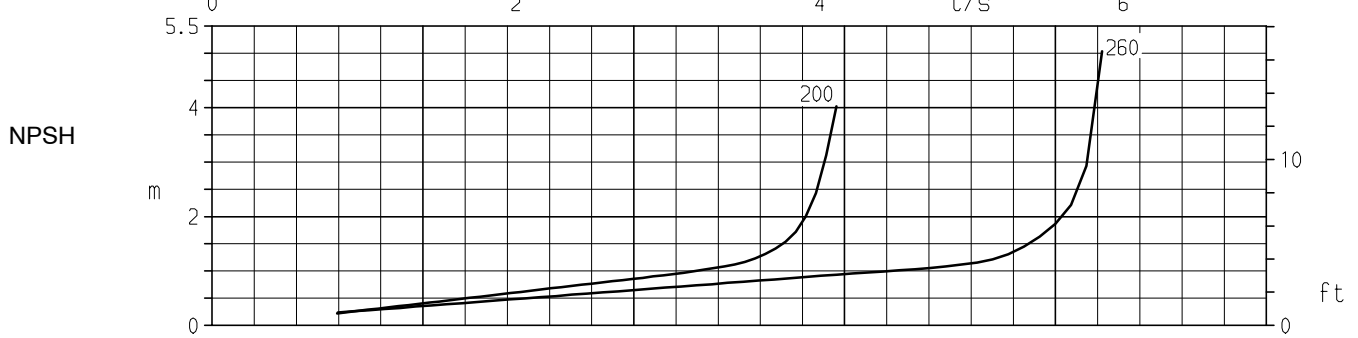
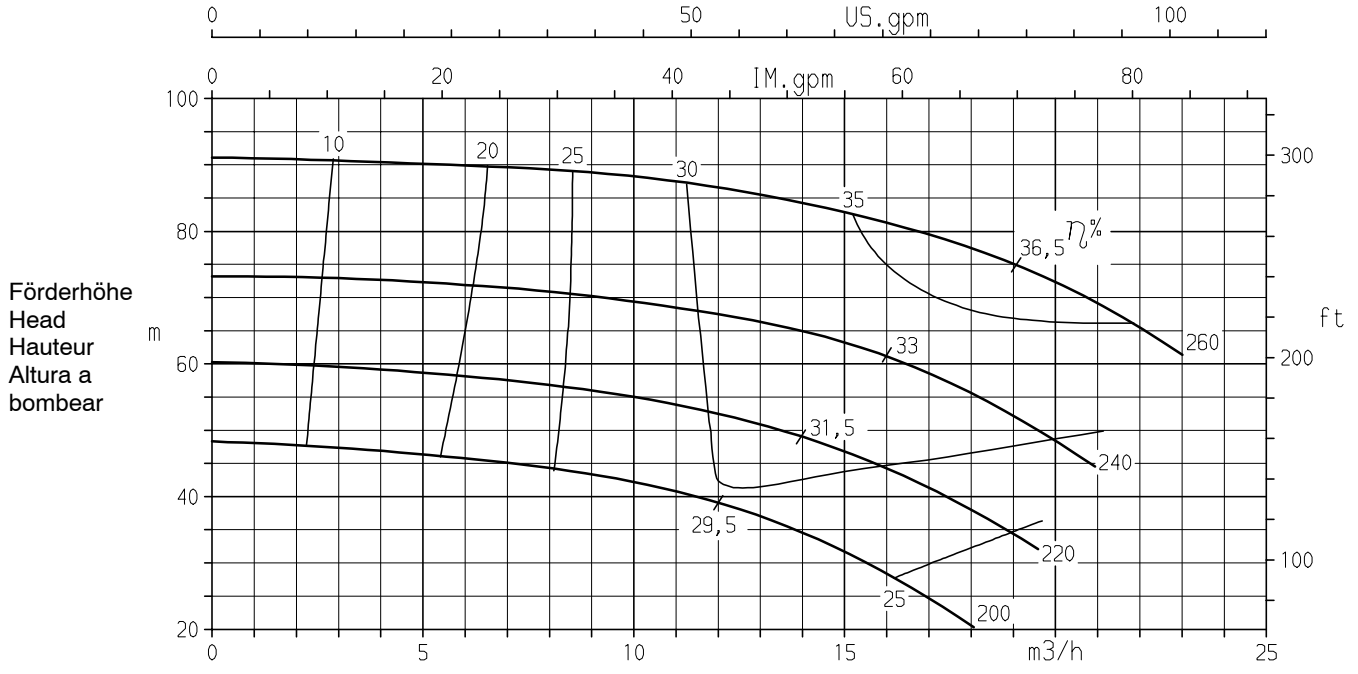

Baureihe Pump type	Modèle Tipo	Nennzahl Nom. speed	Vitesse nom. Revoluciones nom.	 <p>KSB Aktiengesellschaft Industrie- und Wassertechnik Postfach 1361, 91253 Pegnitz Bahnhofplatz 1, 91257 Pegnitz</p>
CPKO	32-250	2900 1/min		
Angebots-Nr. Project No.	No. de l'offre Oferta-No.	Pos.-Nr. Item No.	No. de pos. No. de pos.	

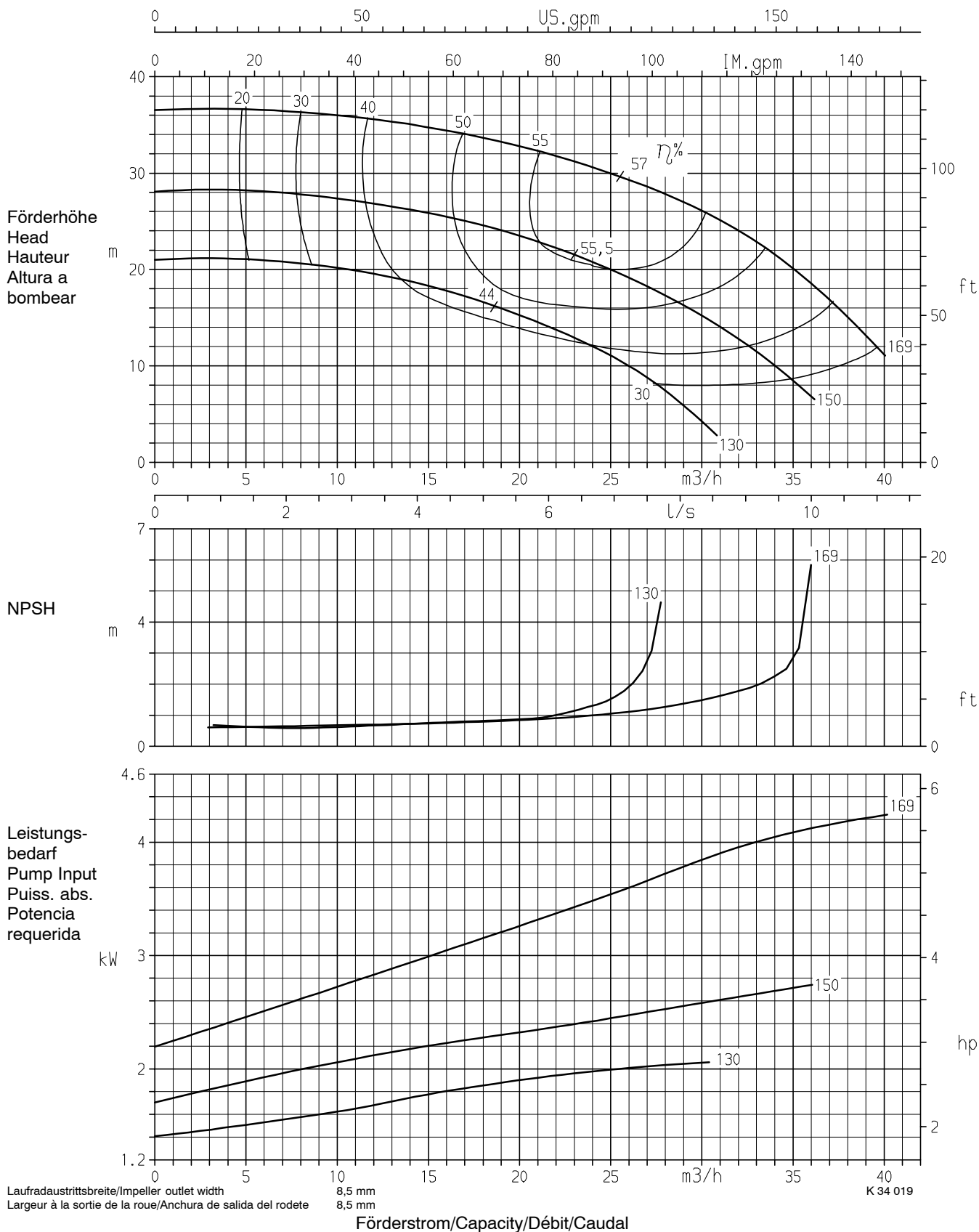

Laufradaustrittsbreite/Impeller outlet width 6,5 mm
 Largeur à la sortie de la roue/Anchura de salida del rodeté 6,5 mm
 Förderstrom/Capacity/Débit/Caudal K 34 017

Baureihe Pump type	Modèle Tipo	Nennzahl Nom. speed	Vitesse nom. Revoluciones nom.	 KSB KSB Aktiengesellschaft Industrie- und Wassertechnik Postfach 1361, 91253 Pegnitz Bahnhofplatz 1, 91257 Pegnitz
CPKO	40-160	2900 1/min		
Angebots-Nr. Project No.	No. de l'offre Oferta-No.	Pos.-Nr. Item No.	No. de pos. No. de pos.	



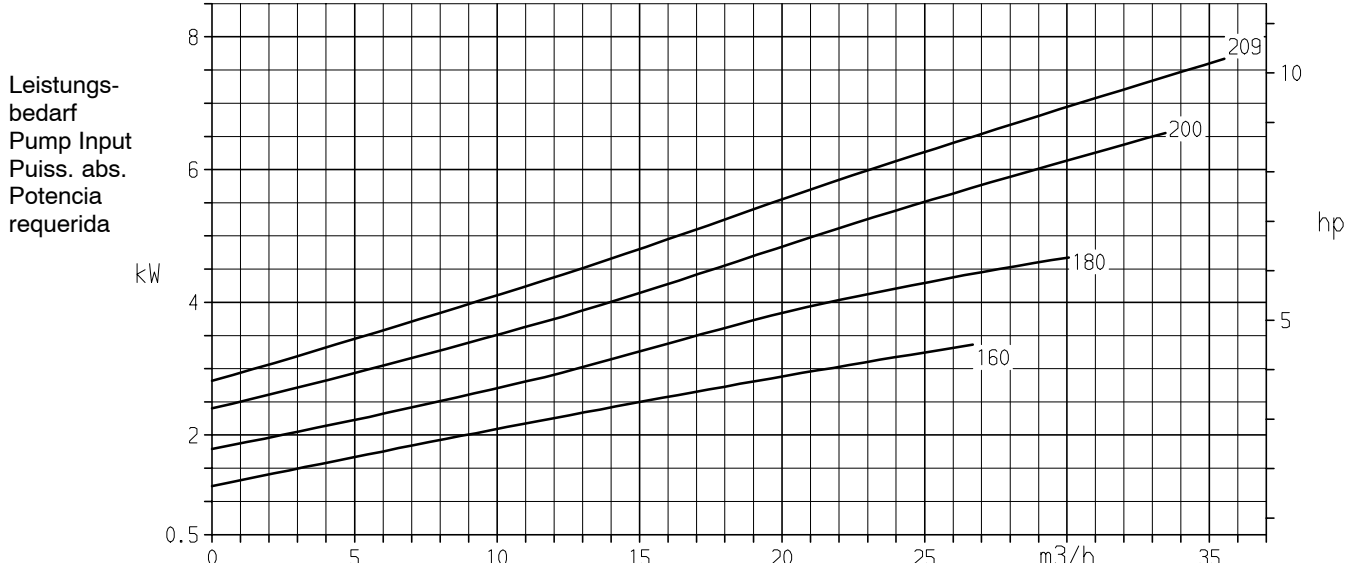
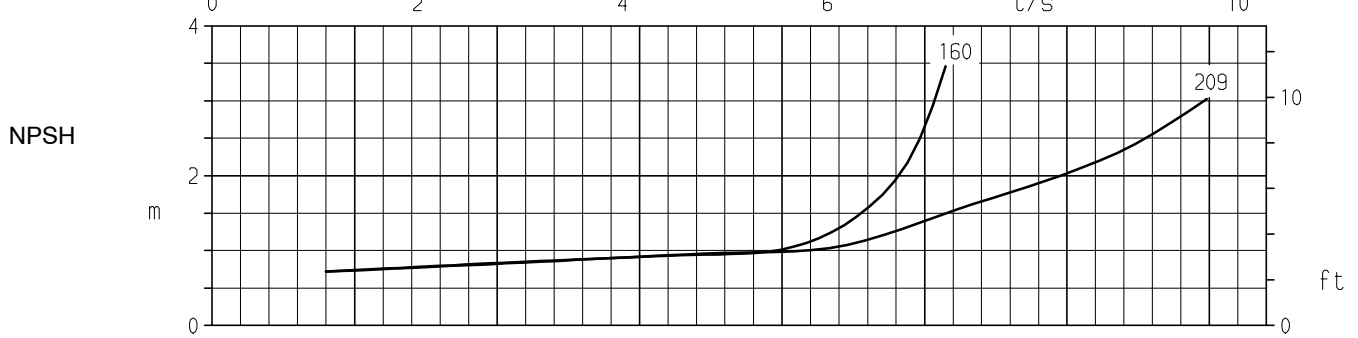
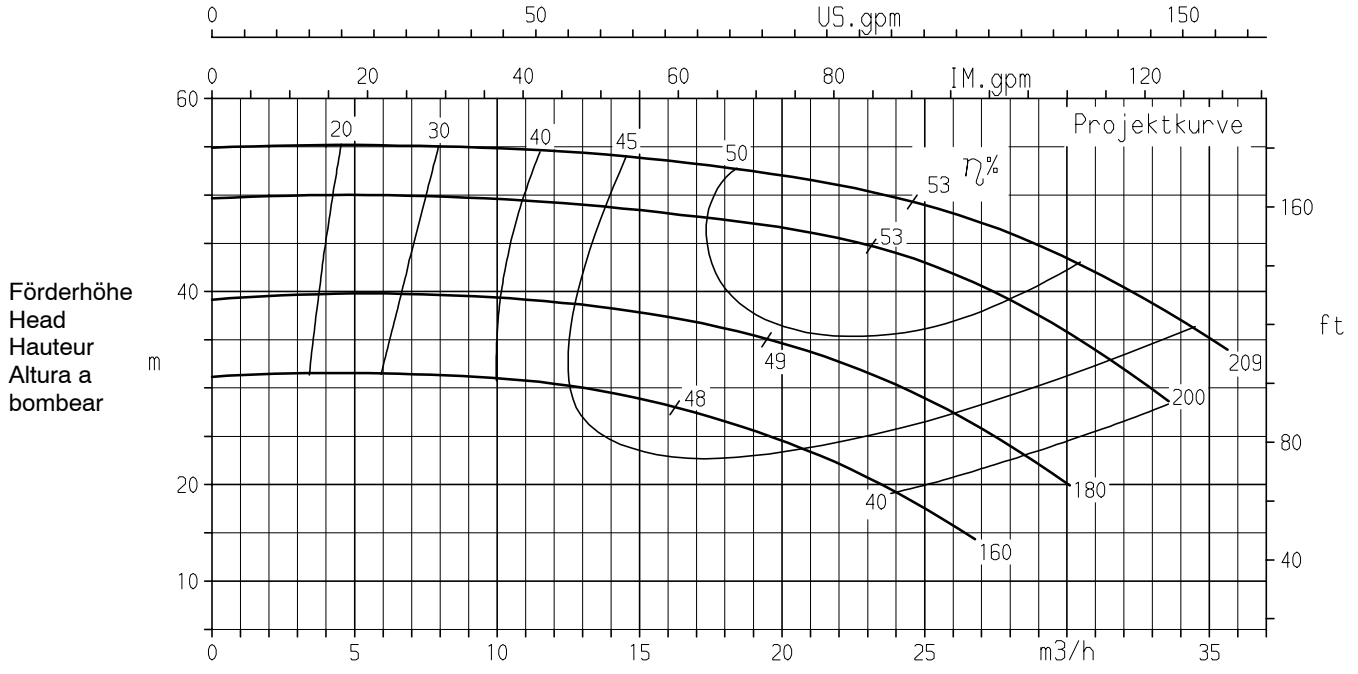

Baureihe Pump type	Modèle Tipo	Nenn Drehzahl Nom. speed	Vitesse nom. Revoluciones nom.	 KSB KSB Aktiengesellschaft Industrie- und Wassertechnik Postfach 1361, 91253 Pegnitz Bahnhofplatz 1, 91257 Pegnitz
CPKO	40-200	2900 1/min		
Angebots-Nr. Project No.	No. de l'offre Oferta-No.	Pos.-Nr. Item No.	No. de pos. No. de pos.	

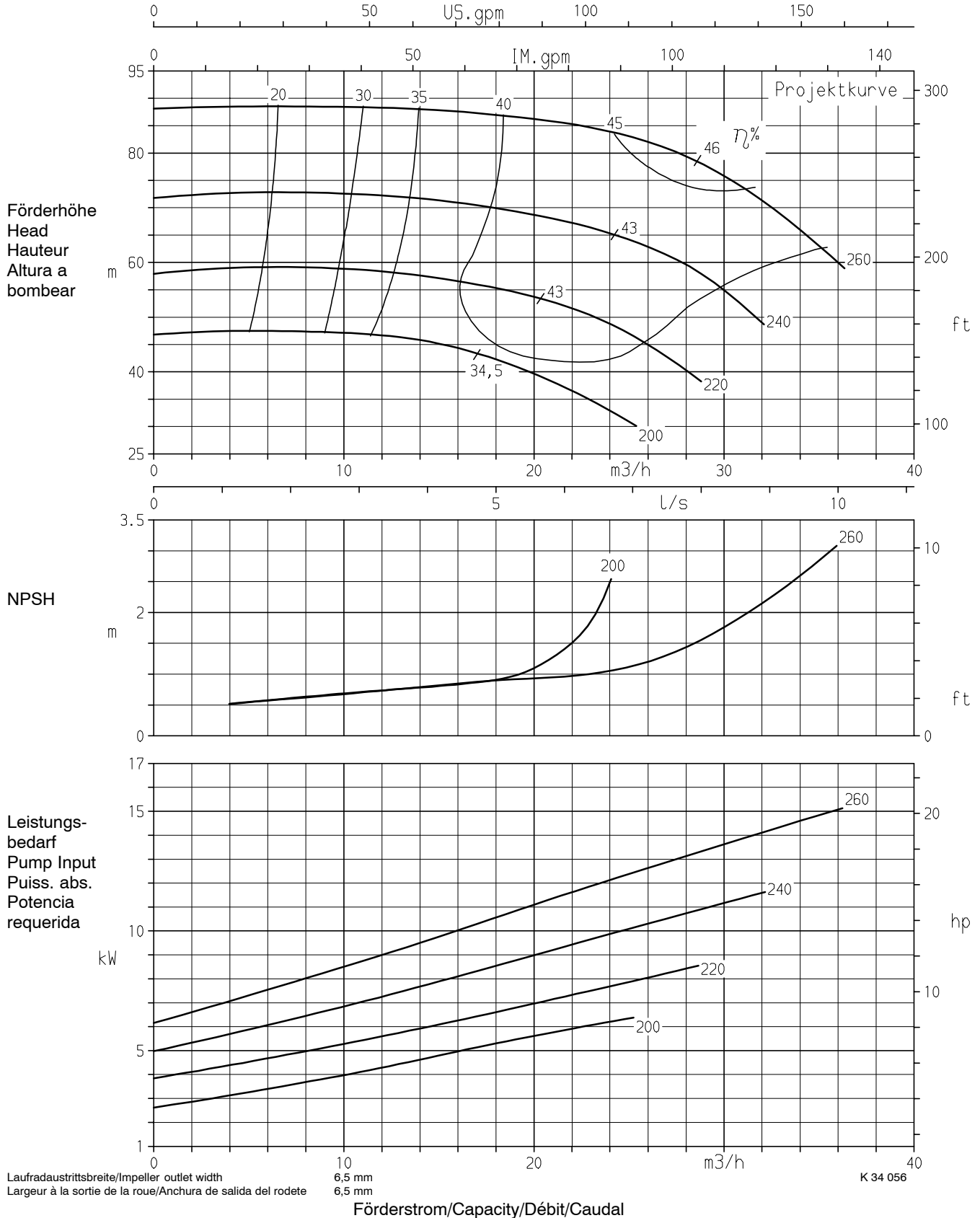

Laufradaustrittsbreite/Impeller outlet width 6,5 mm
 Largeur à la sortie de la roue/Anchura de salida del rodete 6,5 mm
 Förderstrom/Capacity/Débit/Caudal K 34 021

Baureihe Pump type	Modèle Tipo	Nenn Drehzahl Nom. speed	Vitesse nom. Revoluciones nom.	 KSB KSB Aktiengesellschaft Industrie- und Wassertechnik Postfach 1361, 91253 Pegnitz Bahnhofplatz 1, 91257 Pegnitz
CPKO	40-250	2900 1/min		
Angebots-Nr. Project No.	No. de l'offre Oferta-No.	Pos.-Nr. Item No.	No. de pos. No. de pos.	



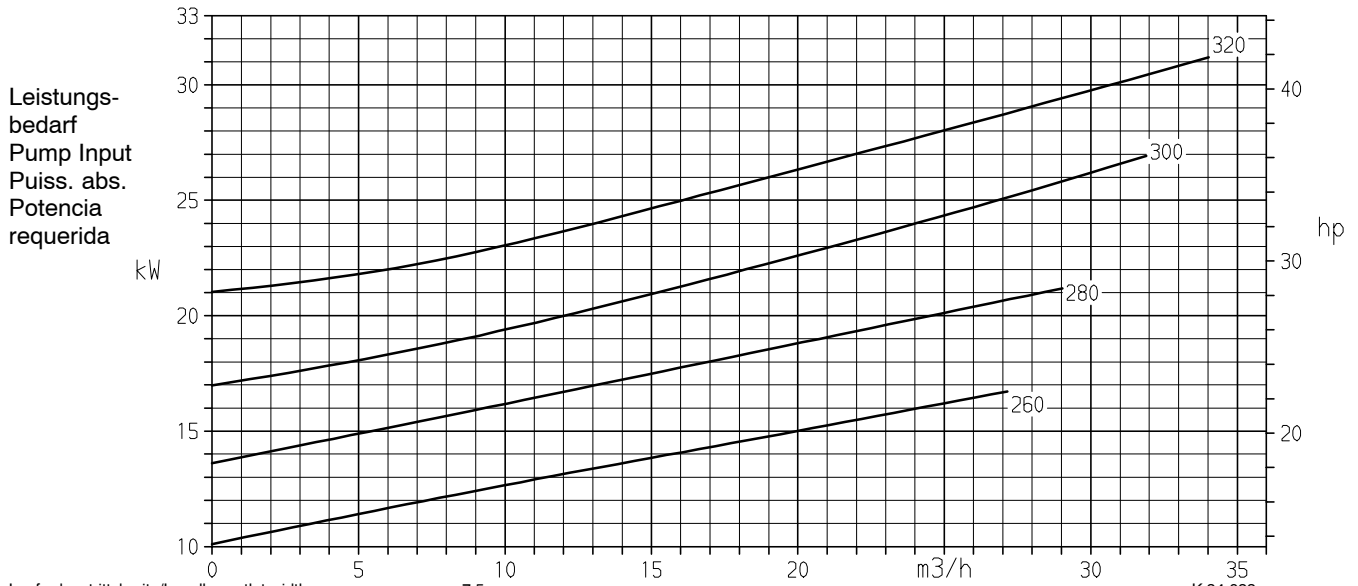
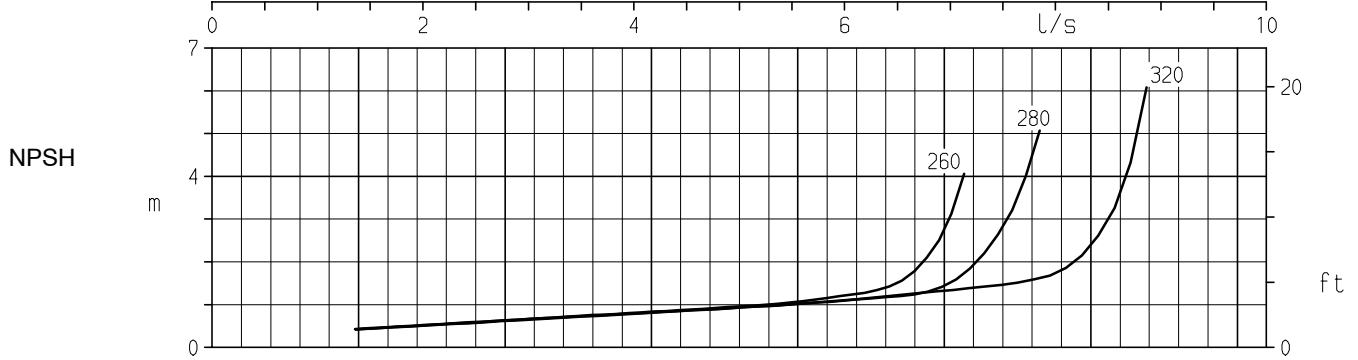
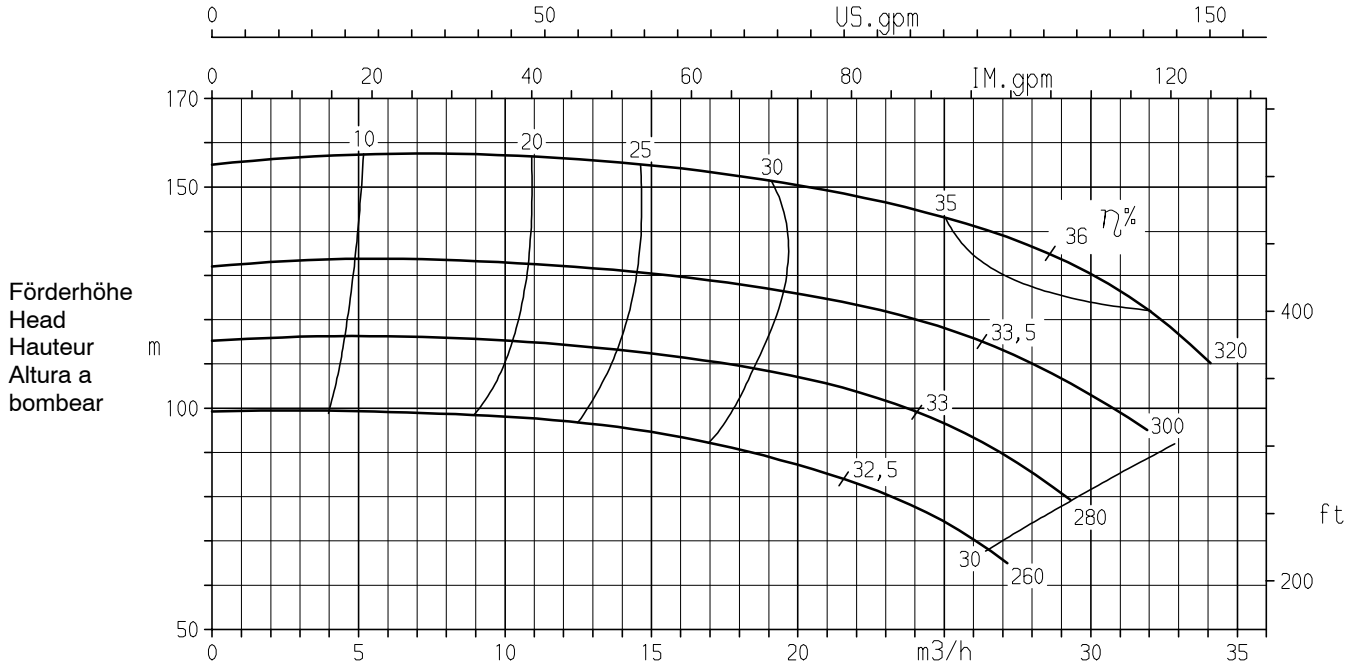

Baureihe Pump type CPKO	Modèle Tipo 40-315	Nenn Drehzahl Nom. speed 2900 1/min	Vitesse nom. Revoluciones nom.	 KSB KSB Aktiengesellschaft Industrie- und Wassertechnik Postfach 1361, 91253 Pegnitz Bahnhofplatz 1, 91257 Pegnitz
Angebots-Nr. Project No.	No. de l'offre Oferta-No.	Pos.-Nr. Item No.	No. de pos. No. de pos.	



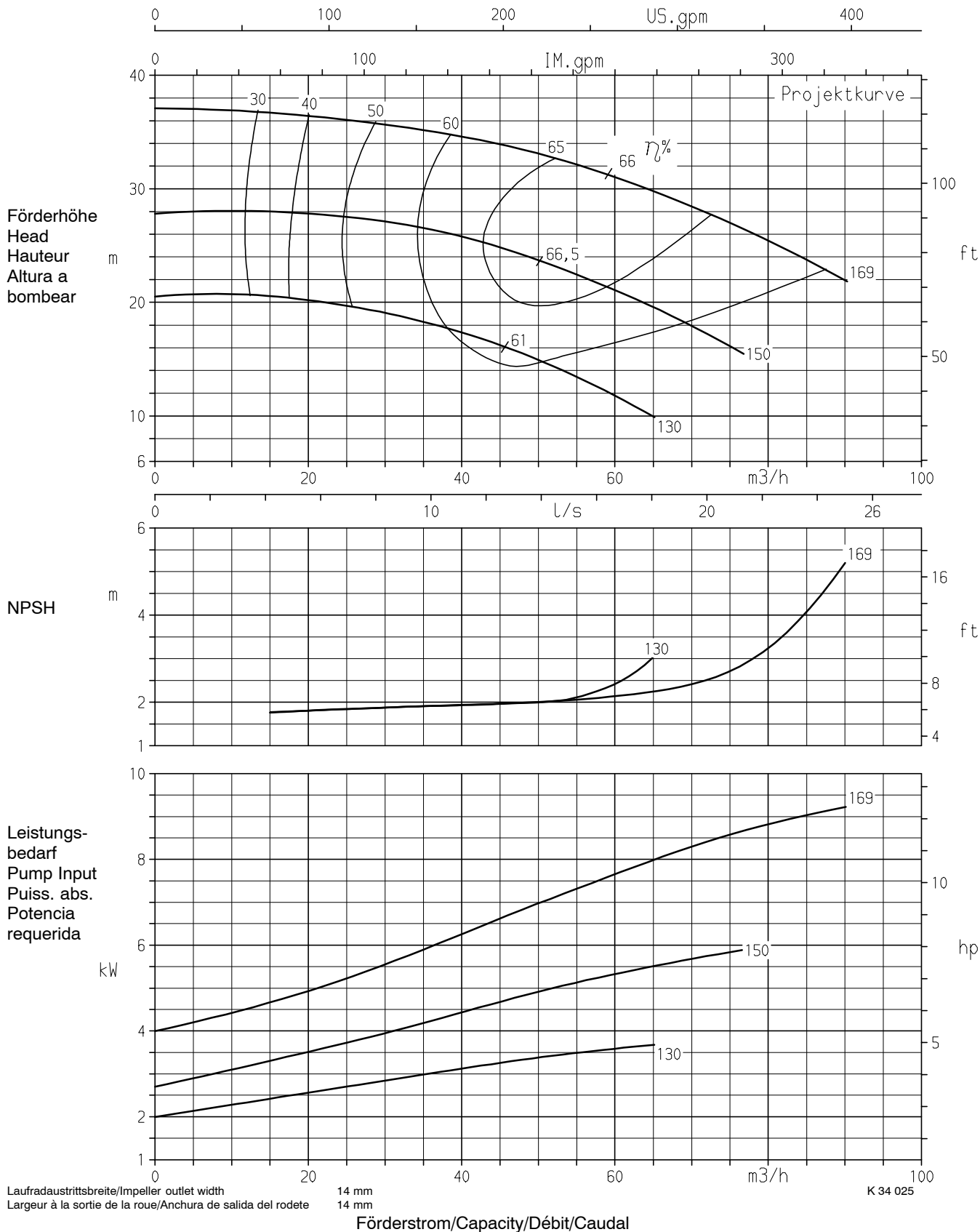

Laufraudaustrittsweite/Impeller outlet width 7,5 mm
 Largeur à la sortie de la roue/Anchura de salida del rodete 7,5 mm
 Förderstrom/Capacity/Débit/Caudal K 34 023

Baureihe Pump type	Modèle Tipo	Nenn Drehzahl Nom. speed	Vitesse nom. Revoluciones nom.	 KSB KSB Aktiengesellschaft Industrie- und Wassertechnik Postfach 1361, 91253 Pegnitz Bahnhofplatz 1, 91257 Pegnitz
CPKO	50-160	2900 1/min		
Angebots-Nr. Project No.	No. de l'offre Oferta-No.	Pos.-Nr. Item No.	No. de pos. No. de pos.	

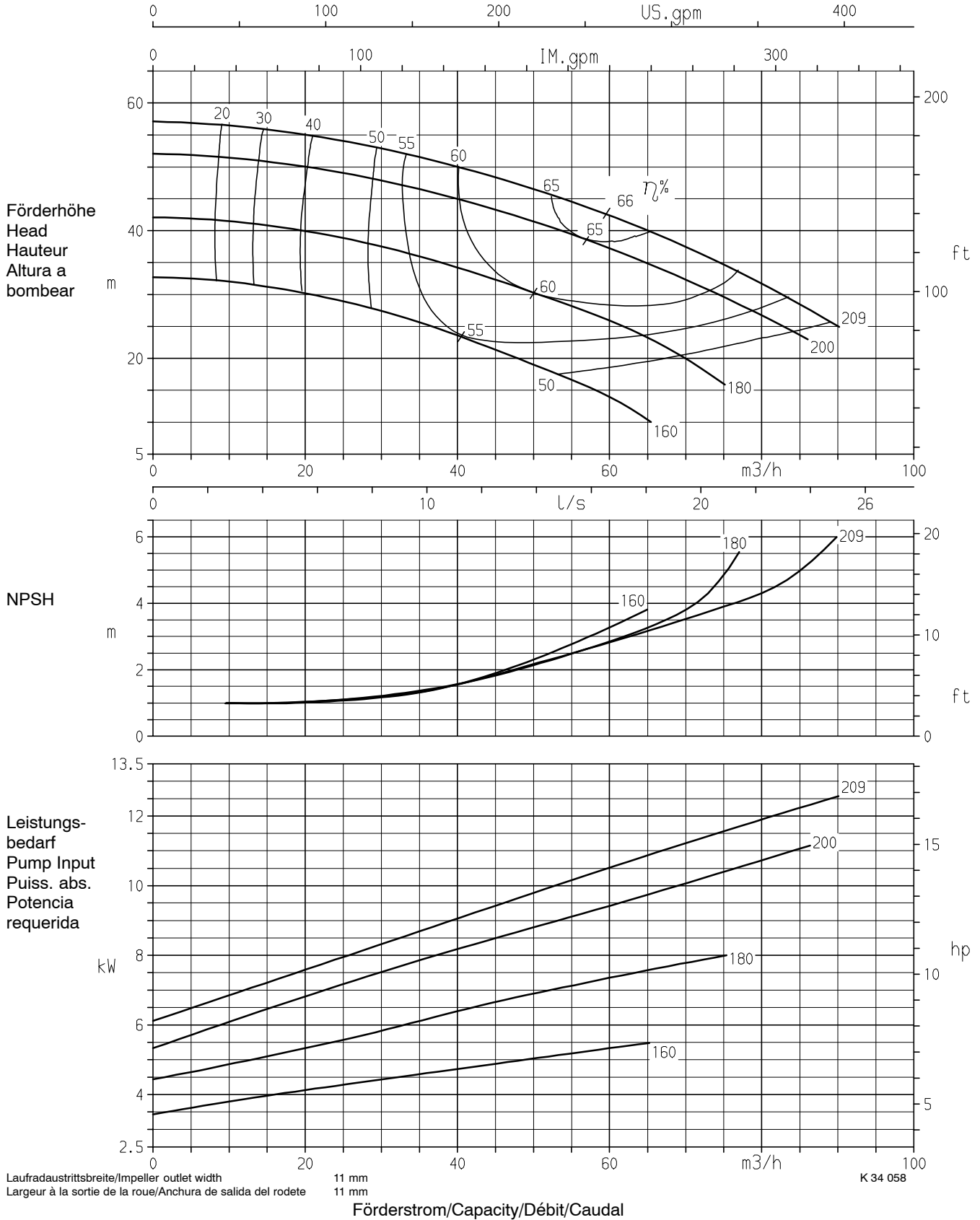

Baureihe Pump type	Modèle Tipo	Nenn Drehzahl Nom. speed	Vitesse nom. Revoluciones nom.	 <p>KSB Aktiengesellschaft Industrie- und Wassertechnik Postfach 1361, 91253 Pegnitz Bahnhofplatz 1, 91257 Pegnitz</p>
CPKO	50-200	2900 1/min		
Angebots-Nr. Project No.	No. de l'offre Oferta-No.	Pos.-Nr. Item No.	No. de pos. No. de pos.	



Baureihe Pump type	Modèle Tipo	Nenn Drehzahl Nom. speed	Vitesse nom. Revoluciones nom.	 KSB KSB Aktiengesellschaft Industrie- und Wassertechnik Postfach 1361, 91253 Pegnitz Bahnhofplatz 1, 91257 Pegnitz
CPKO	50-250	2900 1/min		
Angebots-Nr. Project No.	No. de l'offre Oferta-No.	Pos.-Nr. Item No.	No. de pos. No. de pos.	

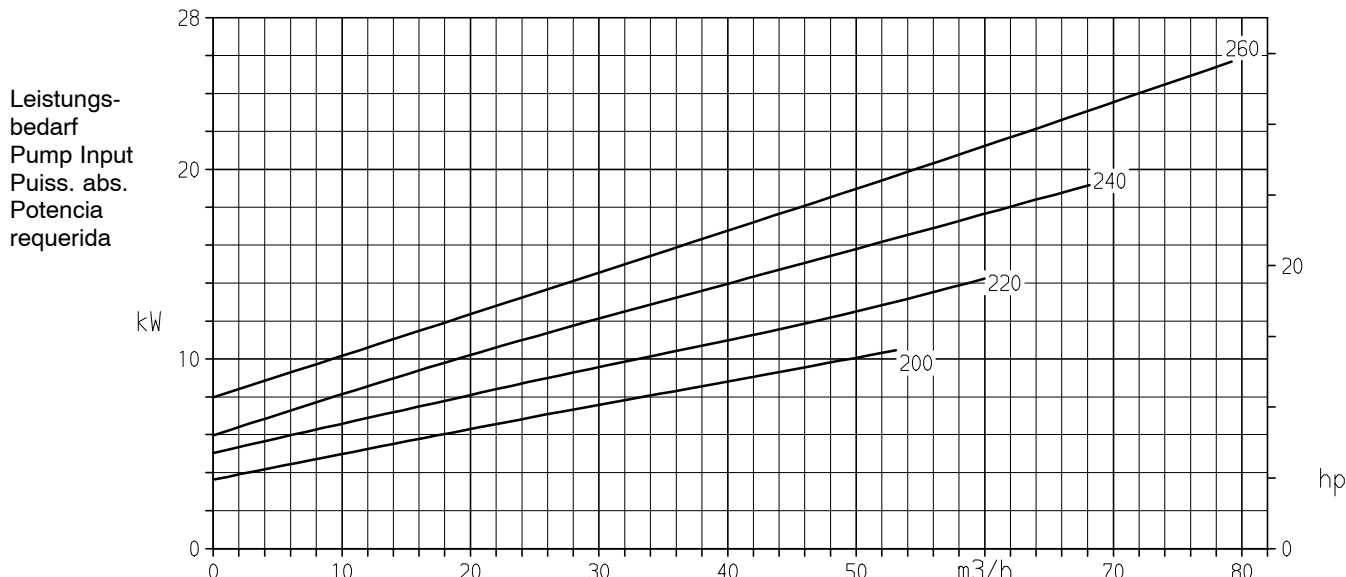
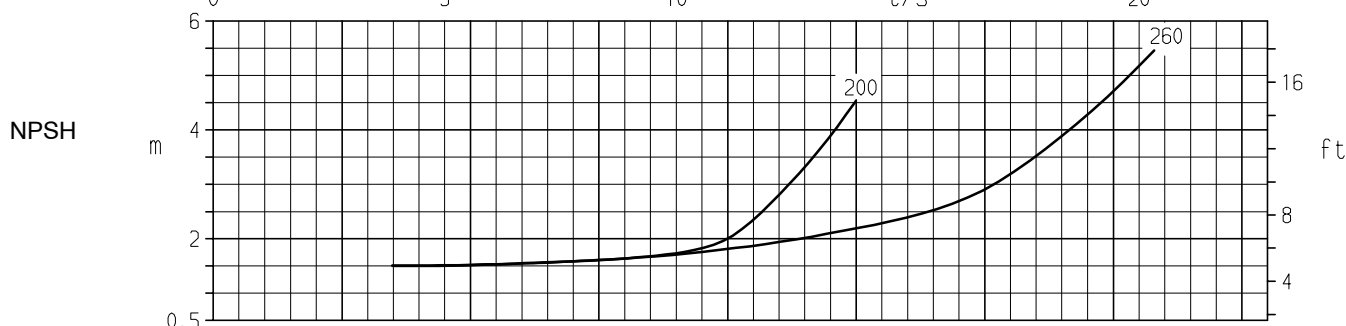
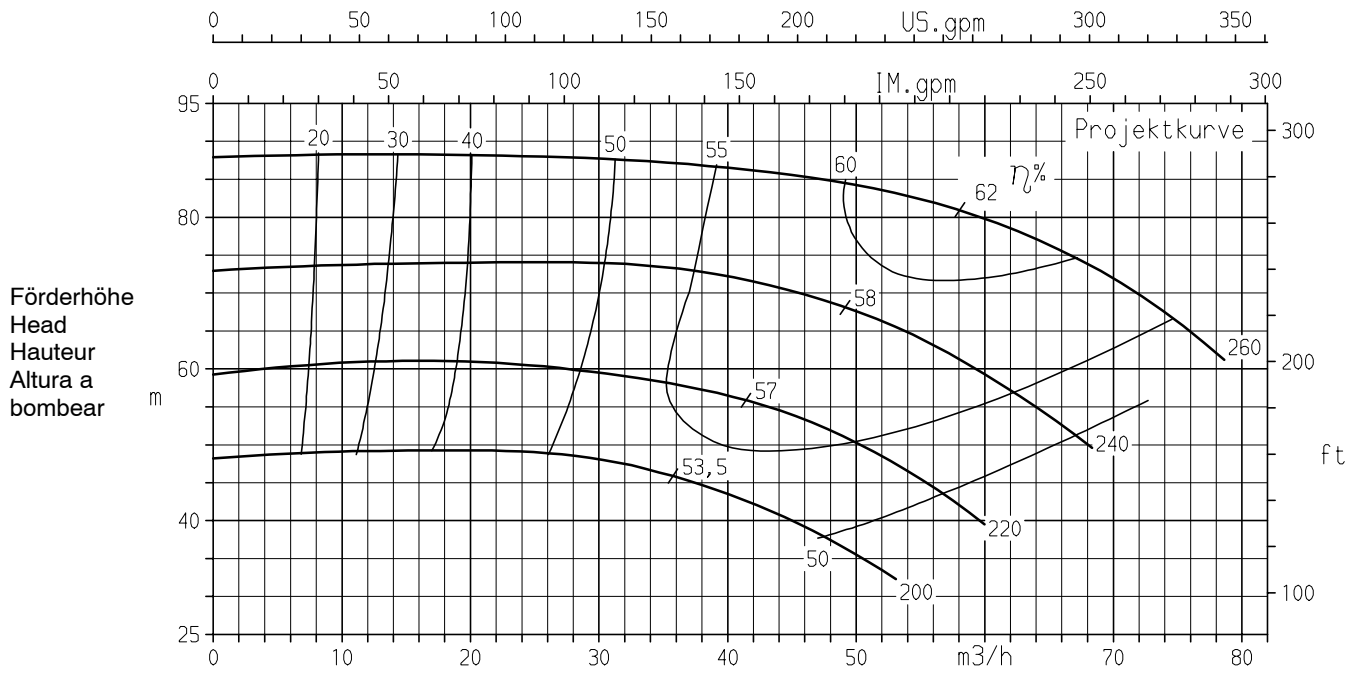

Laufradaustrittsbreite/Impeller outlet width
Largeur à la sortie de la roue/Anchura de salida del rodete

9,5 mm
9,5 mm

Förderstrom/Capacity/Débit/Caudal

K 34 027

Baureihe Pump type	Modèle Tipo	Nennzahl Nom. speed	Vitesse nom. Revoluciones nom.	 KSB
CPKO	50-315	2900 1/min		
Angebots-Nr. Project No.	No. de l'offre Oferta-No.	Pos.-Nr. Item No.	No. de pos. No. de pos.	KSB Aktiengesellschaft Industrie- und Wassertechnik Postfach 1361, 91253 Pegnitz Bahnhofplatz 1, 91257 Pegnitz

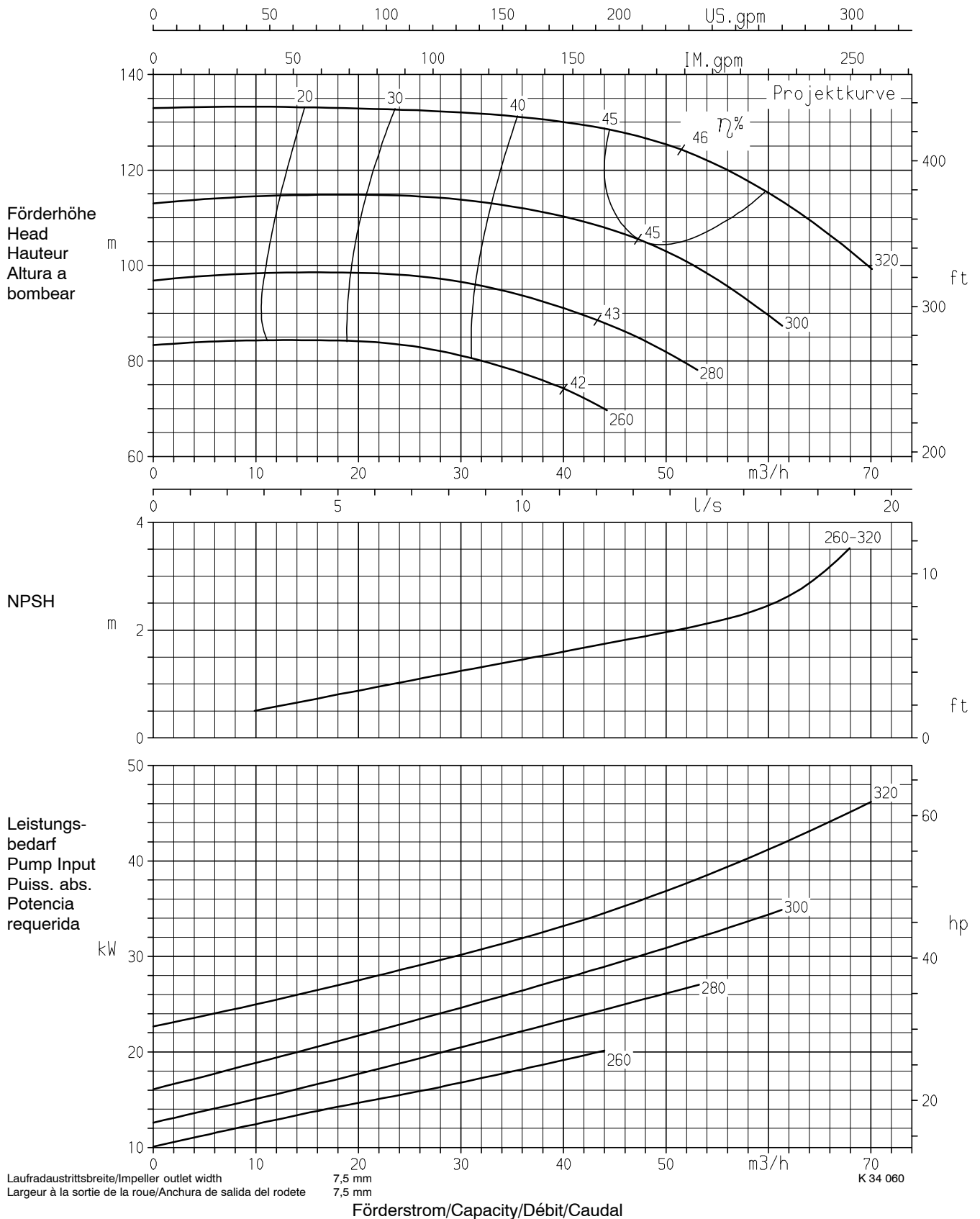

Baureihe Pump type	Modèle Tipo	Nenn Drehzahl Nom. speed	Vitesse nom. Revoluciones nom.	 KSB KSB Aktiengesellschaft Industrie- und Wassertechnik Postfach 1361, 91253 Pegnitz Bahnhofplatz 1, 91257 Pegnitz
CPKO	65-160	2900 1/min		
Angebots-Nr. Project No.	No. de l'offre Oferta-No.	Pos.-Nr. Item No.	No. de pos. No. de pos.	

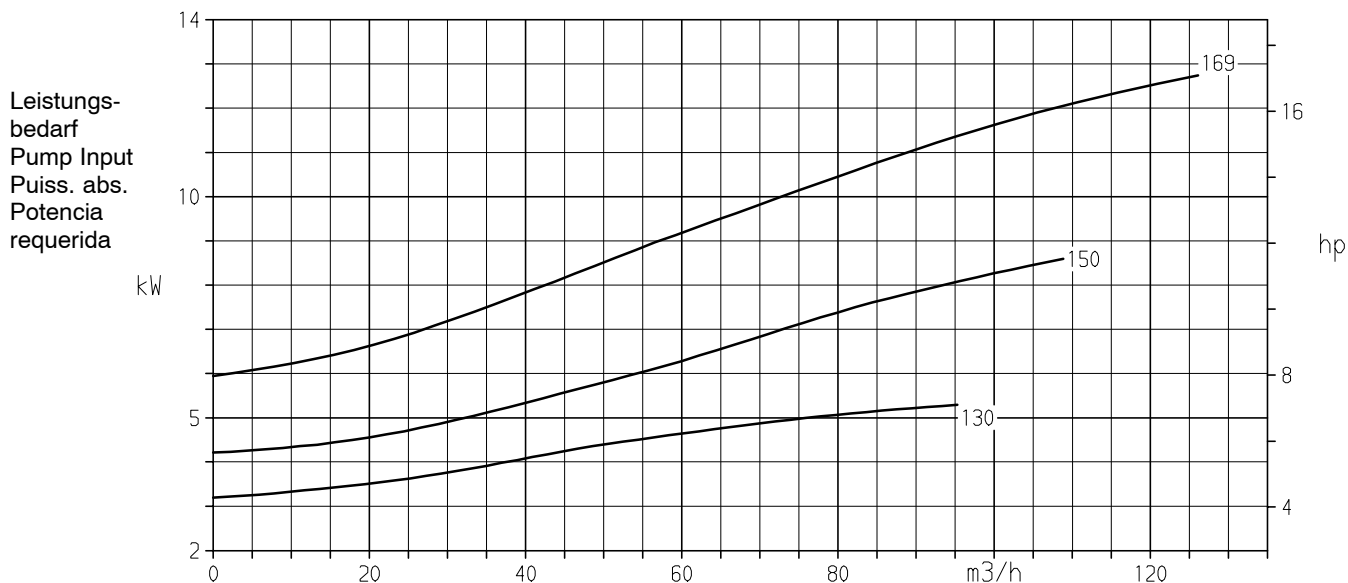
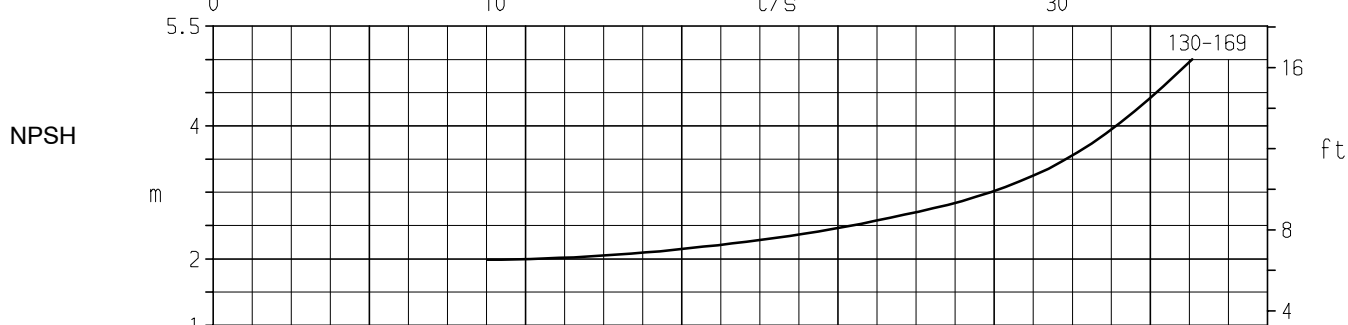
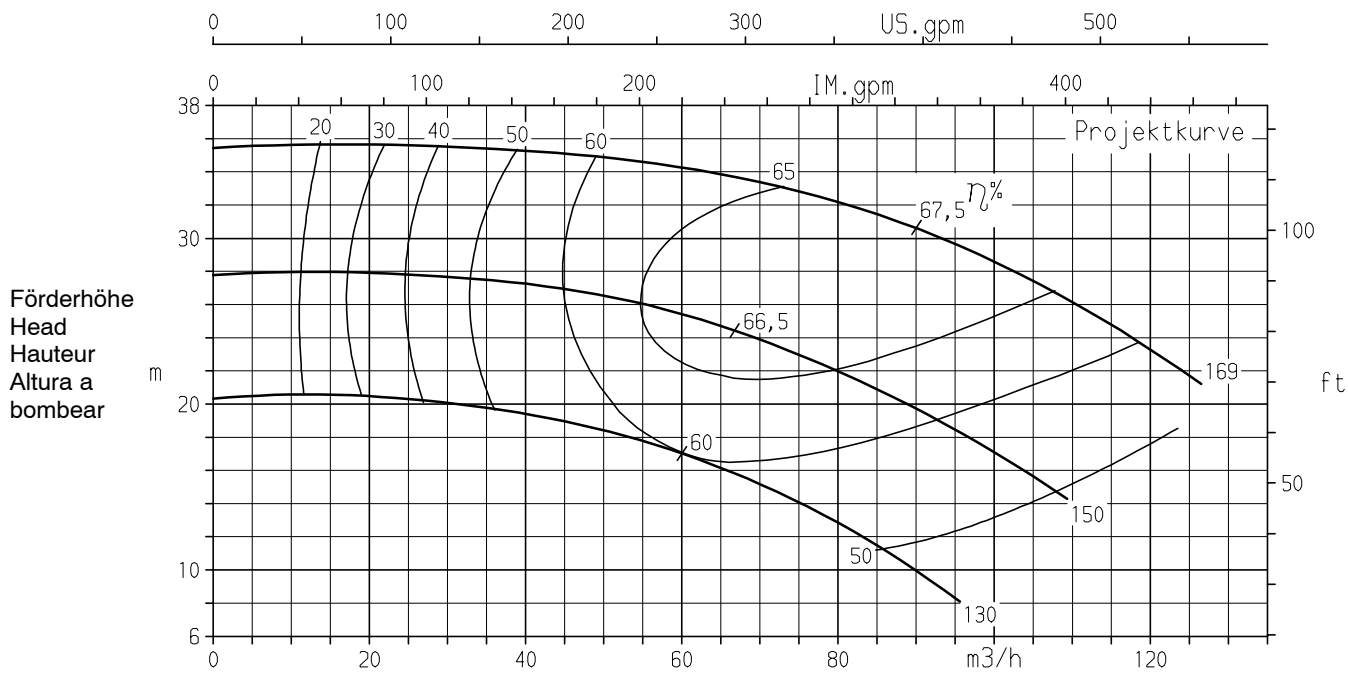

Laufradaustrittsbreite/Impeller outlet width
 Largeur à la sortie de la roue/Anchura de salida del rodete

19 mm
 19 mm

K 34 029

Förderstrom/Capacity/Débit/Caudal

Baureihe Pump type	Modèle Tipo	Nenn Drehzahl Nom. speed	Vitesse nom. Revoluciones nom.	 <p>KSB Aktiengesellschaft Industrie- und Wassertechnik Postfach 1361, 91253 Pegnitz Bahnhofplatz 1, 91257 Pegnitz</p>
CPKO	65-200	2900 1/min		
Angebots-Nr. Project No.	No. de l'offre Oferta-No.	Pos.-Nr. Item No.	No. de pos. No. de pos.	

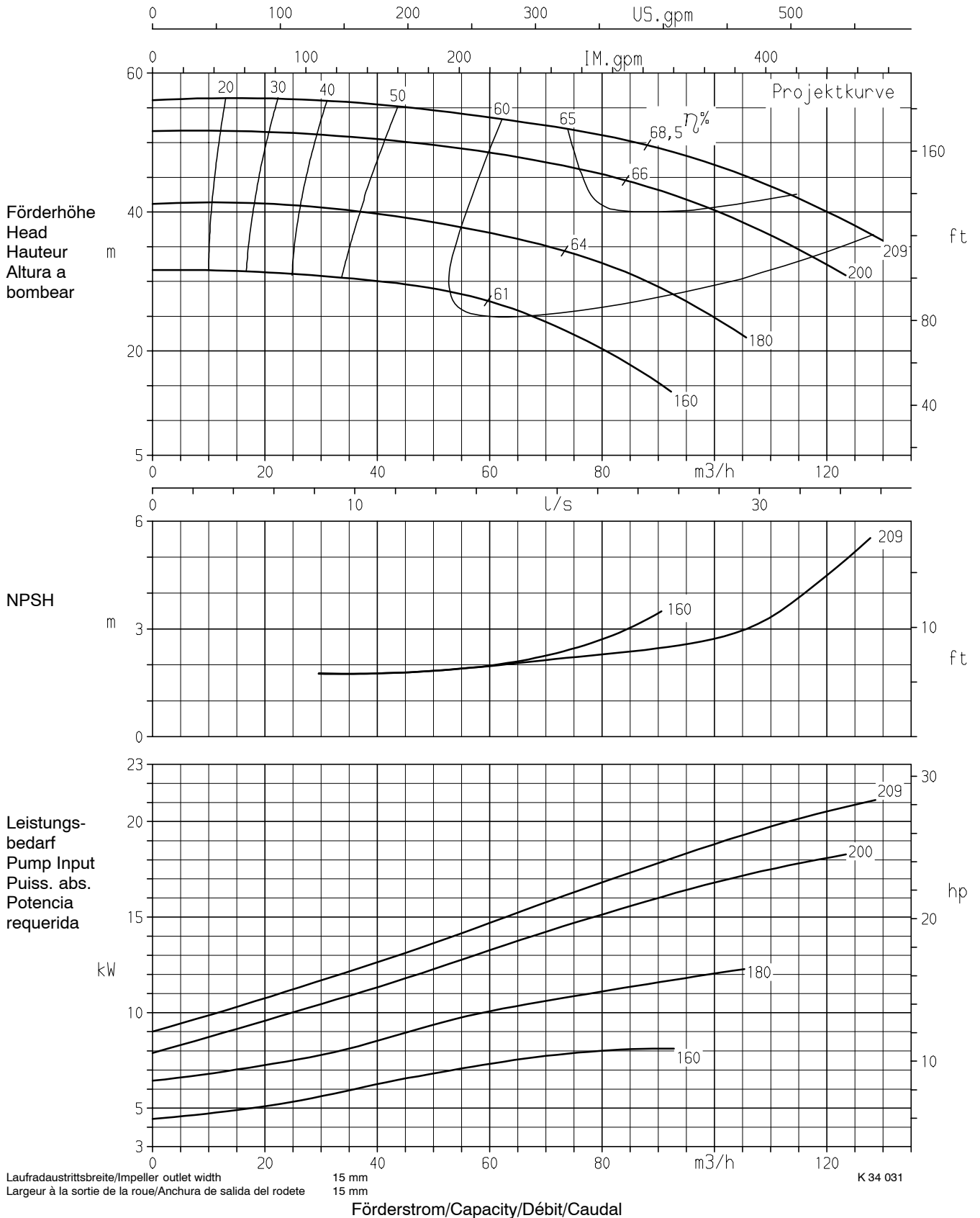

Baureihe Pump type	Modèle Tipo	Nenn Drehzahl Nom. speed	Vitesse nom. Revoluciones nom.	 KSB KSB Aktiengesellschaft Industrie- und Wassertechnik Postfach 1361, 91253 Pegnitz Bahnhofplatz 1, 91257 Pegnitz
CPKO	65-250	2900 1/min		
Angebots-Nr. Project No.	No. de l'offre Oferta-No.	Pos.-Nr. Item No.	No. de pos. No. de pos.	

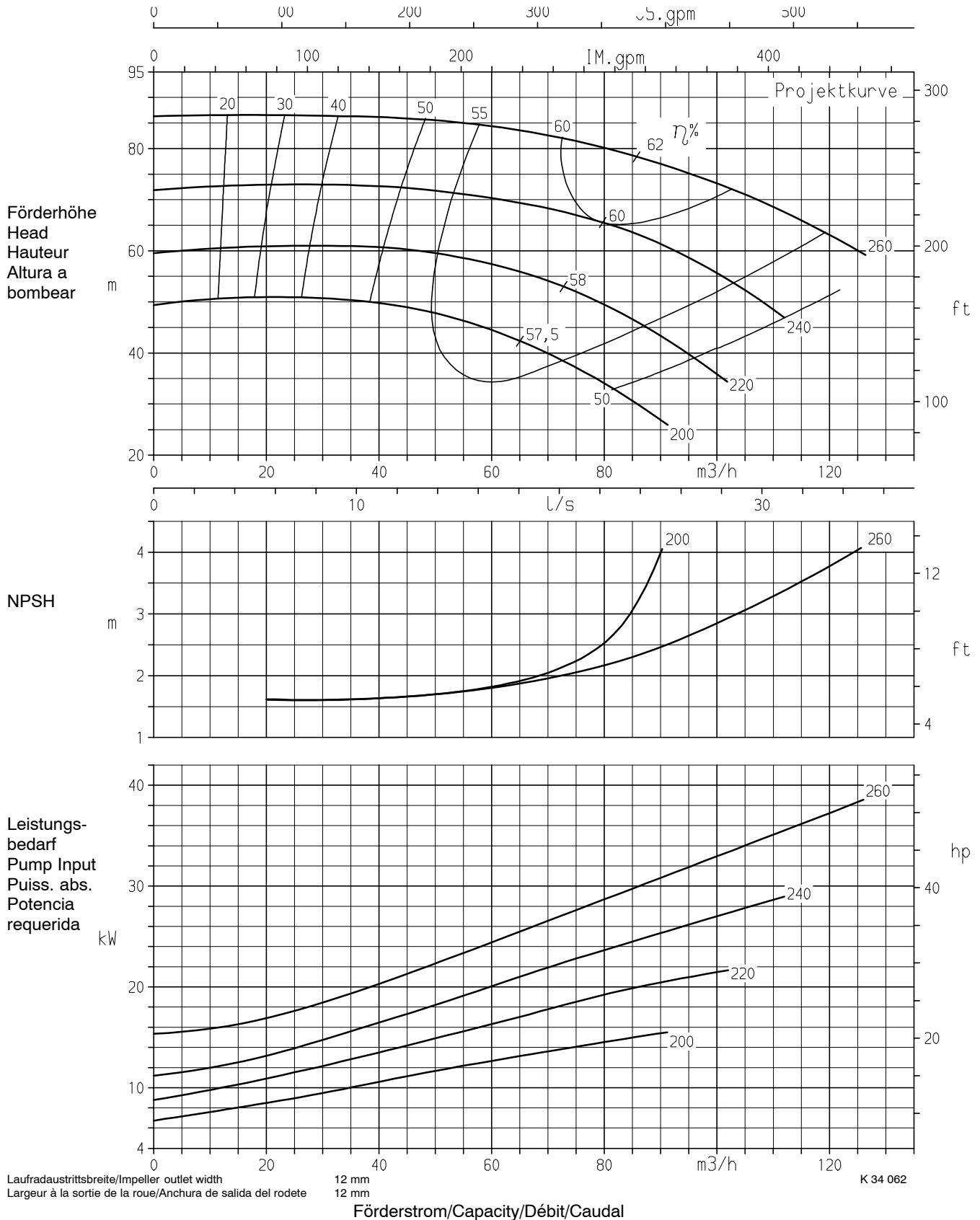

Baureihe Pump type	Modèle Tipo	Nenn Drehzahl Nom. speed	Vitesse nom. Revoluciones nom.	 <p>KSB Aktiengesellschaft Industrie- und Wassertechnik Postfach 1361, 91253 Pegnitz Bahnhofplatz 1, 91257 Pegnitz</p>
CPKO	65-315	2900 1/min		
Angebots-Nr. Project No.	No. de l'offre Oferta-No.	Pos.-Nr. Item No.	No. de pos. No. de pos.	

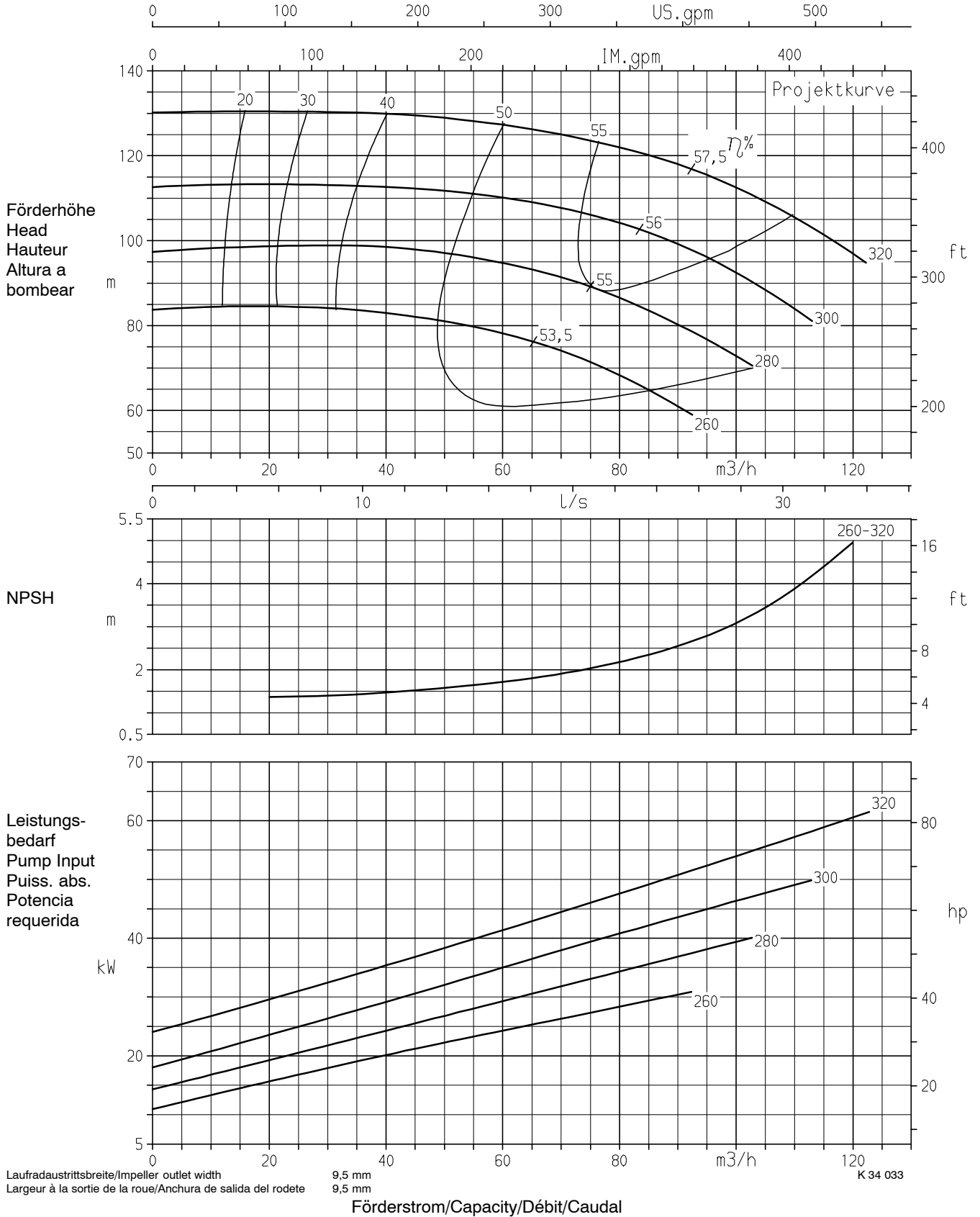

Baureihe Pump type	Modèle Tipo	Nenn Drehzahl Nom. speed	Vitesse nom. Revoluciones nom.	 KSB
CPKO	80-160	2900 1/min		
Angebots-Nr. Project No.	No. de l'offre Oferta-No.	Pos.-Nr. Item No.	No. de pos. No. de pos.	KSB Aktiengesellschaft Industrie- und Wassertechnik Postfach 1361, 91253 Pegnitz Bahnhofplatz 1, 91257 Pegnitz

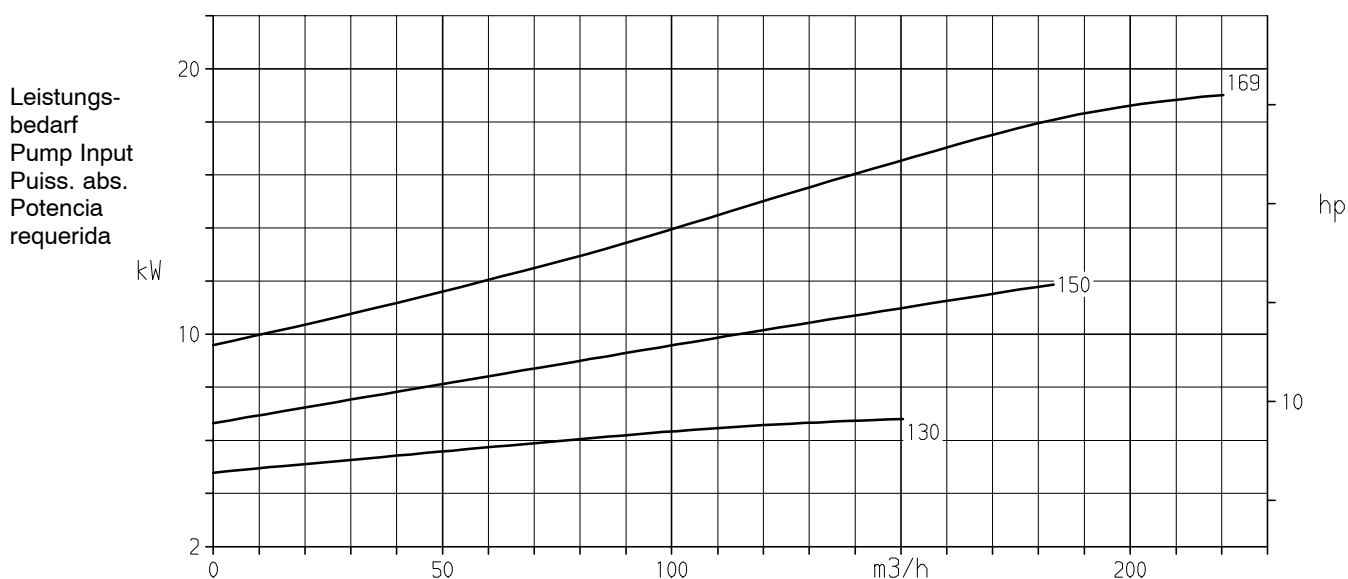
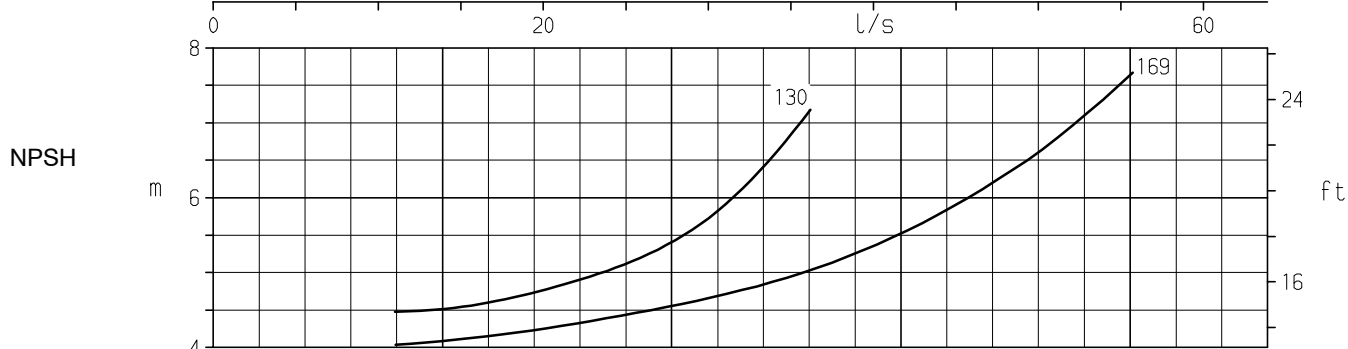
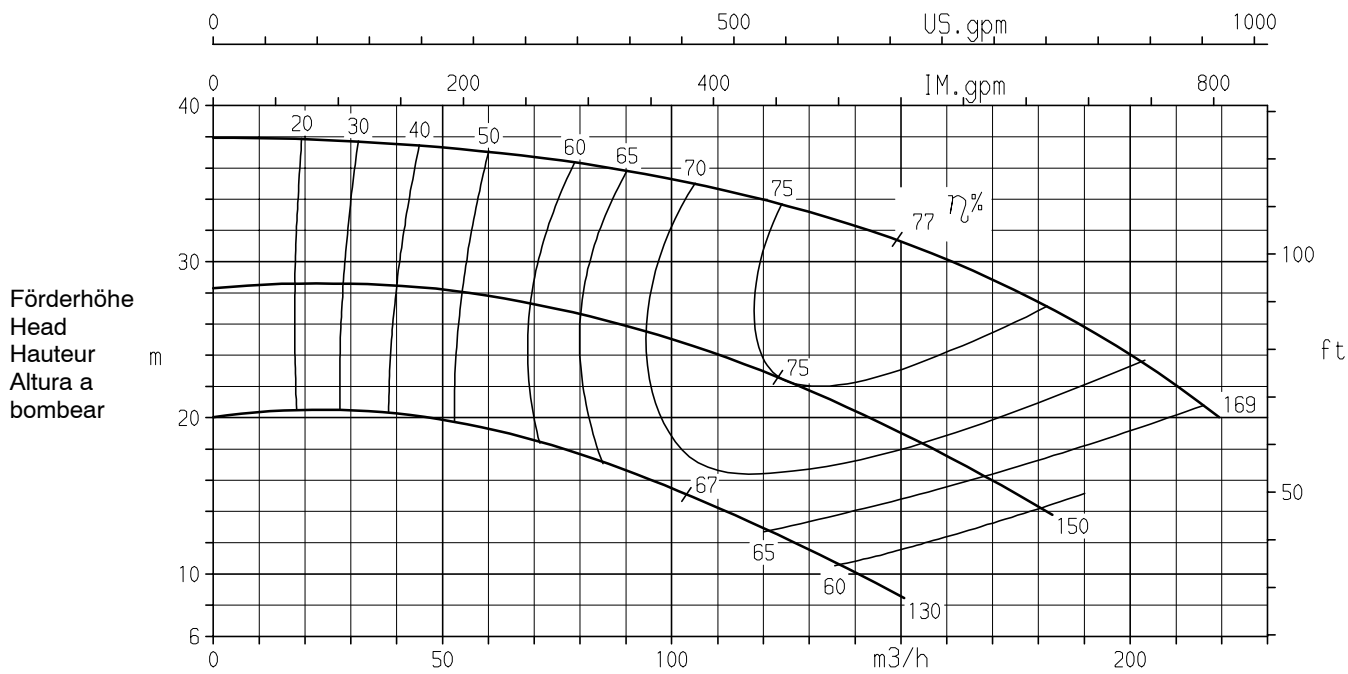

Laufradaustrittsbreite/Impeller outlet width
Largeur à la sortie de la roue/Anchura de salida del rodete

26 mm
26 mm

K 34 035

Förderstrom/Capacity/Débit/Caudal

Baureihe Pump type	Modèle Tipo	Nennzahl Nom. speed	Vitesse nom. Revoluciones nom.	 KSB KSB Aktiengesellschaft Industrie- und Wassertechnik Postfach 1361, 91253 Pegnitz Bahnhofplatz 1, 91257 Pegnitz
CPKO	80-200	2900 1/min		
Angebots-Nr. Project No.	No. de l'offre Oferta-No.	Pos.-Nr. Item No.	No. de pos. No. de pos.	

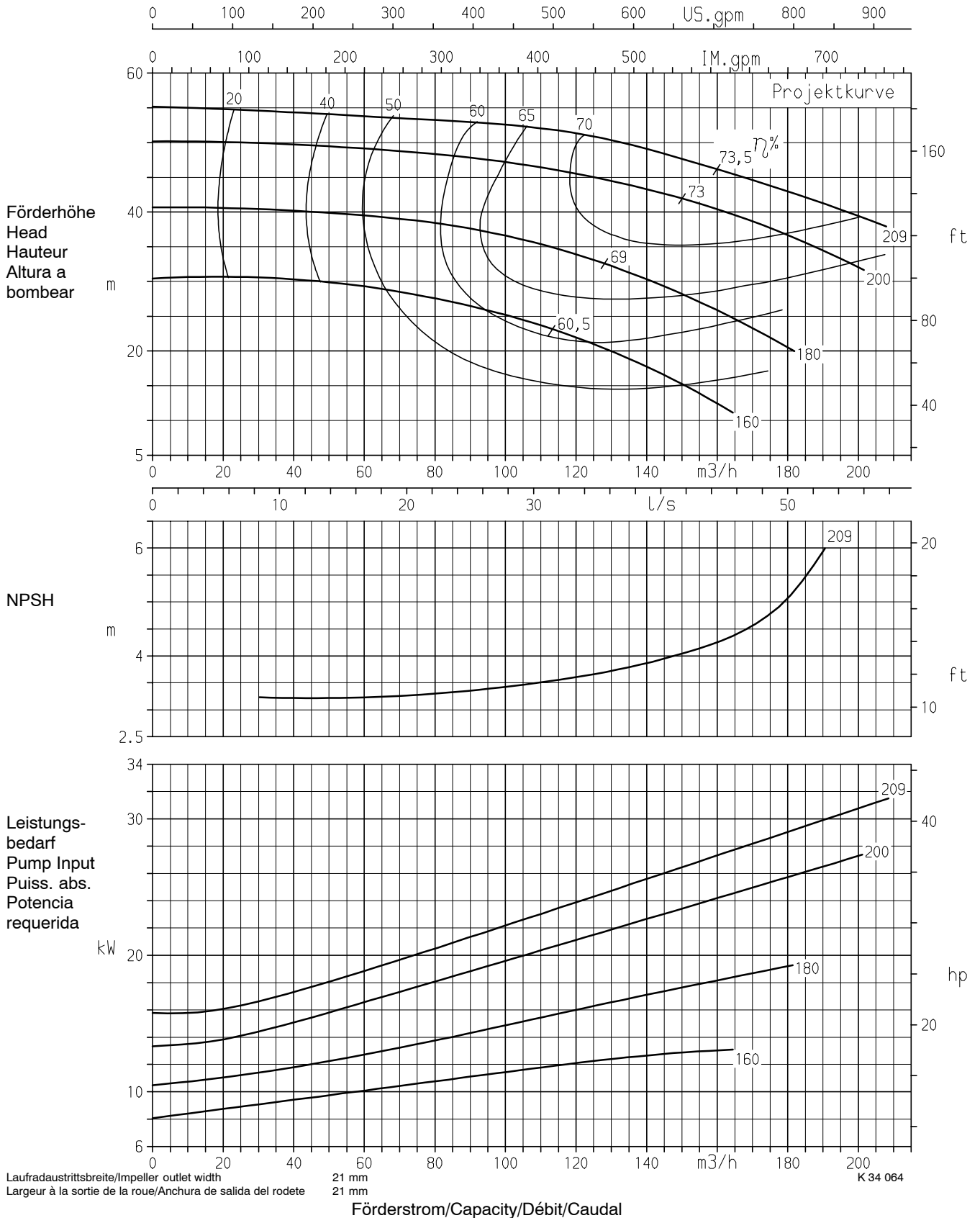

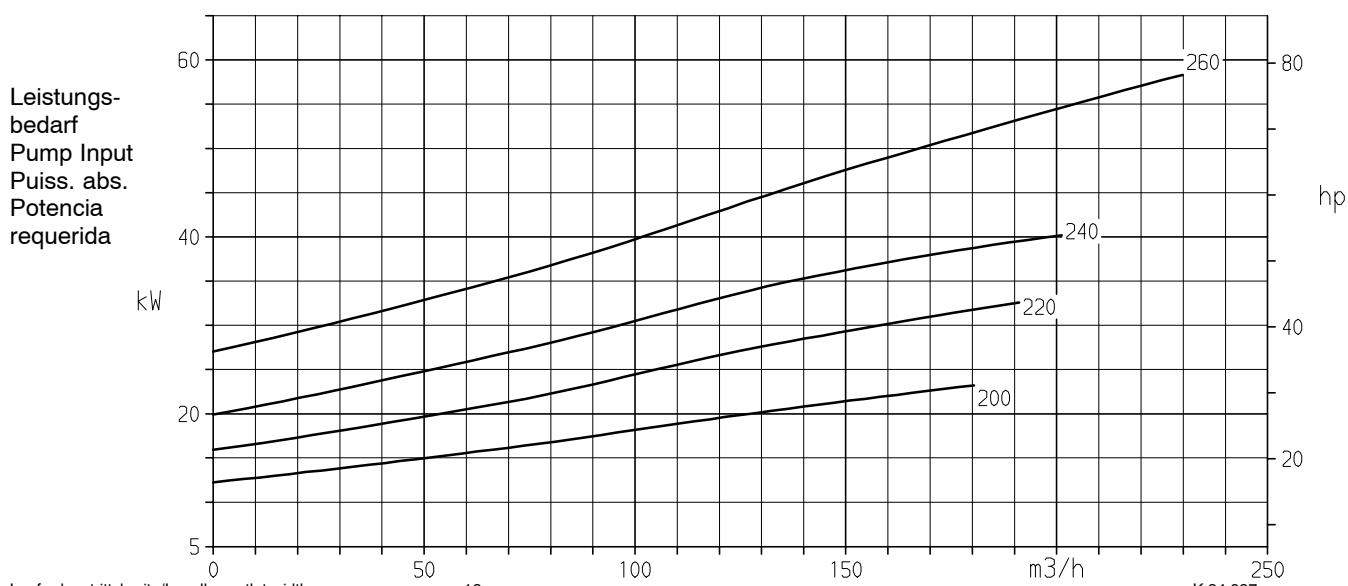
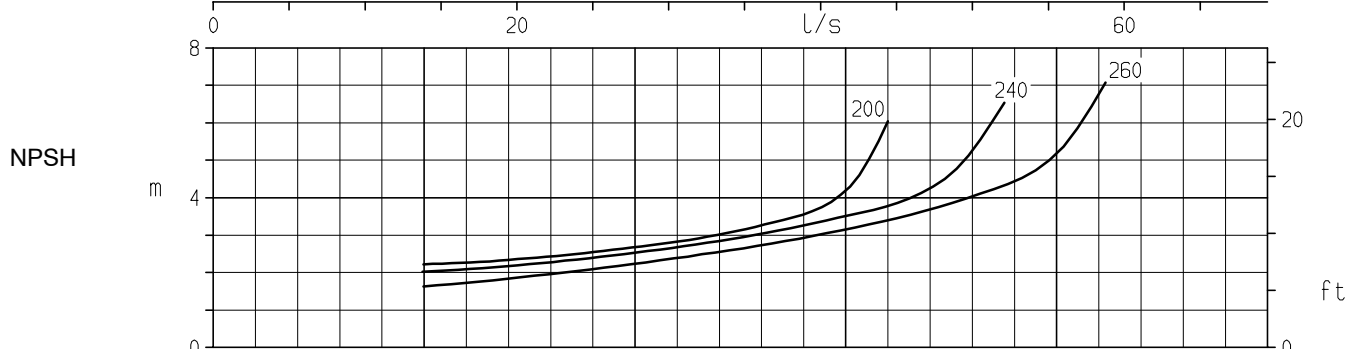
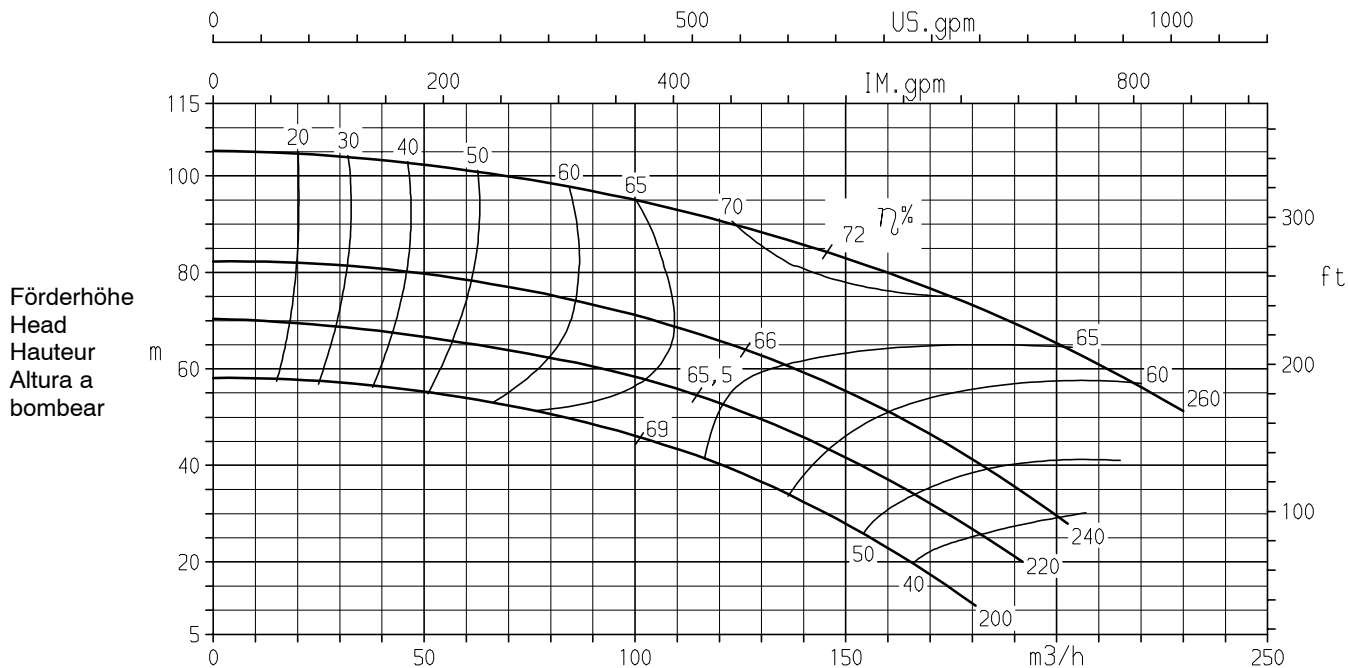

Baureihe Pump type	Modèle Tipo	Nenn Drehzahl Nom. speed	Vitesse nom. Revoluciones nom.	 KSB
CPKO	80-250	2900 1/min		
Angebots-Nr. Project No.	No. de l'offre Oferta-No.	Pos.-Nr. Item No.	No. de pos. No. de pos.	KSB Aktiengesellschaft Industrie- und Wassertechnik Postfach 1361, 91253 Pegnitz Bahnhofplatz 1, 91257 Pegnitz



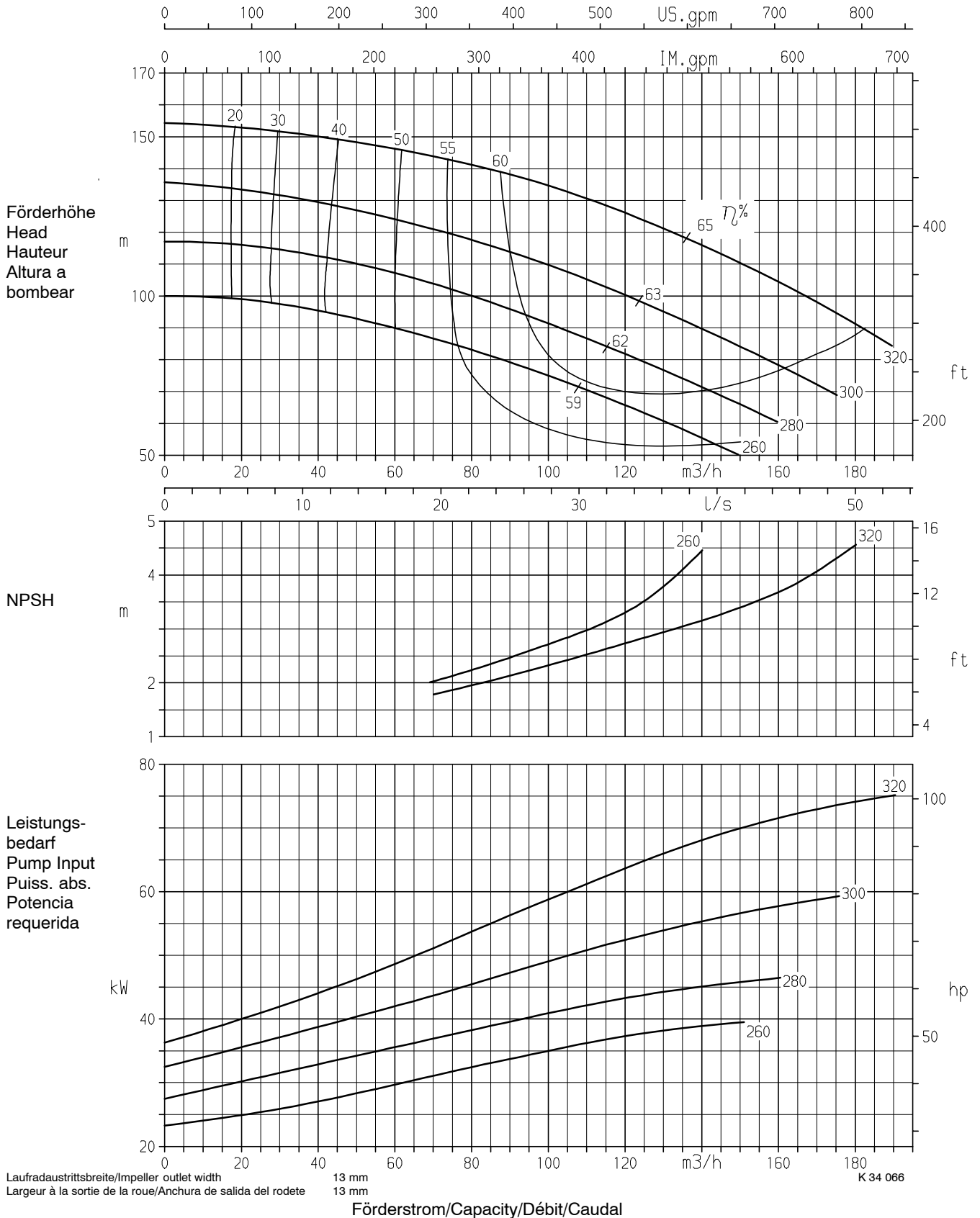

Laufradaustrittsbreite/Impeller outlet width 16 mm 16 mm
 Largeur à la sortie de la roue/Anchura de salida del rodete 16 mm 16 mm
 Förderstrom/Capacity/Débit/Caudal K 34 037

Baureihe Pump type	Modèle Tipo	Nenn Drehzahl Nom. speed	Vitesse nom. Revoluciones nom.	 KSB KSB Aktiengesellschaft Industrie- und Wassertechnik Postfach 1361, 91253 Pegnitz Bahnhofplatz 1, 91257 Pegnitz
CPKO	80-315	2900 1/min		
Angebots-Nr. Project No.	No. de l'offre Oferta-No.	Pos.-Nr. Item No.	No. de pos. No. de pos.	

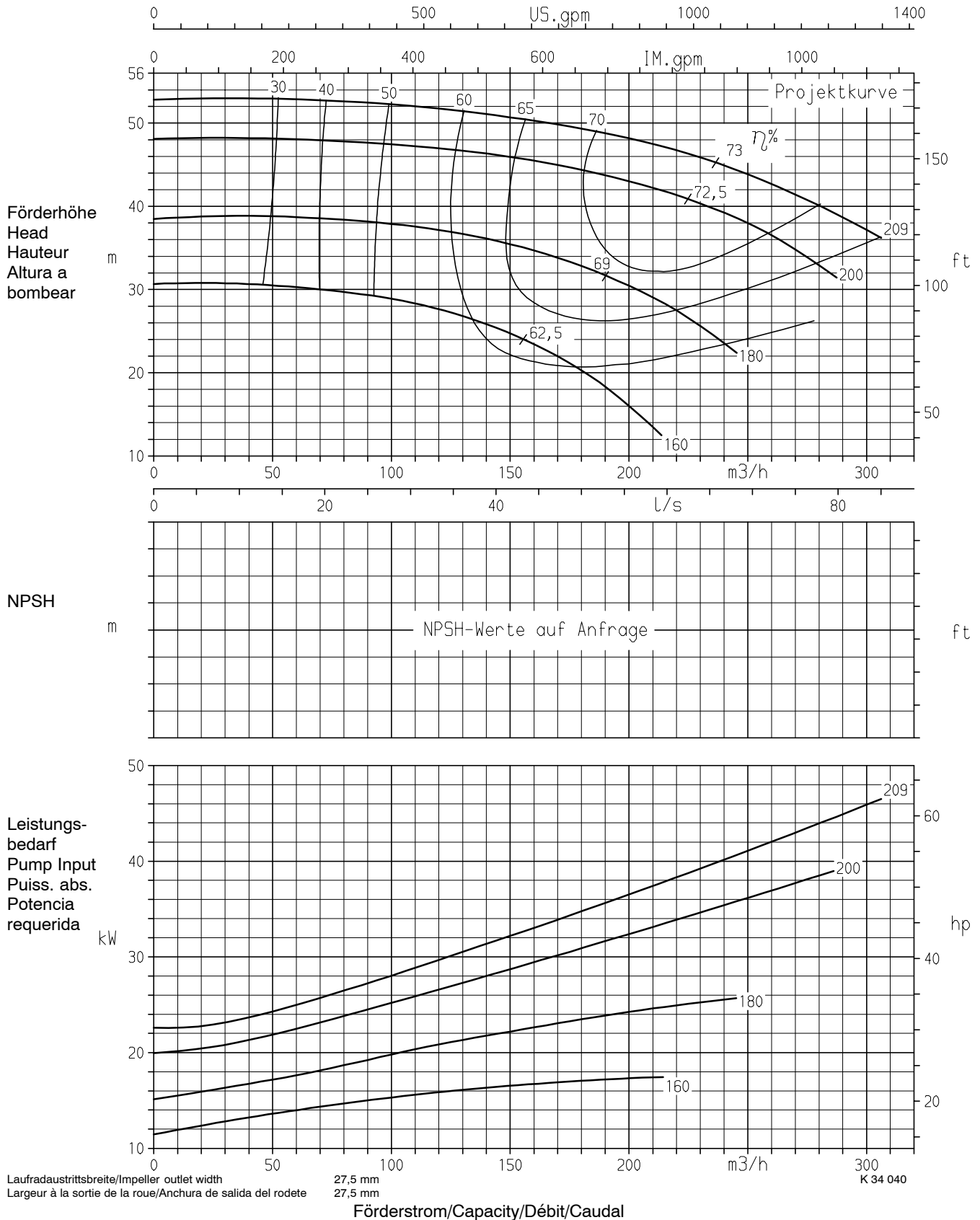

Baureihe Pump type CPKO	Modèle Tipo 100-200	Nenn Drehzahl Nom. speed 2900 1/min	Vitesse nom. Revoluciones nom.	 KSB KSB Aktiengesellschaft Industrie- und Wassertechnik Postfach 1361, 91253 Pegnitz Bahnhofplatz 1, 91257 Pegnitz
Angebots-Nr. Project No.	No. de l'offre Oferta-No.	Pos.-Nr. Item No.	No. de pos. No. de pos.	



Baureihe Pump type	Modèle Tipo	Nenn Drehzahl Nom. speed	Vitesse nom. Revoluciones nom.	 KSB KSB Aktiengesellschaft Industrie- und Wassertechnik Postfach 1361, 91253 Pegnitz Bahnhofplatz 1, 91257 Pegnitz
CPKO	25-160	1450 1/min		
Angebots-Nr. Project No.	No. de l'offre Oferta-No.	Pos.-Nr. Item No.	No. de pos. No. de pos.	

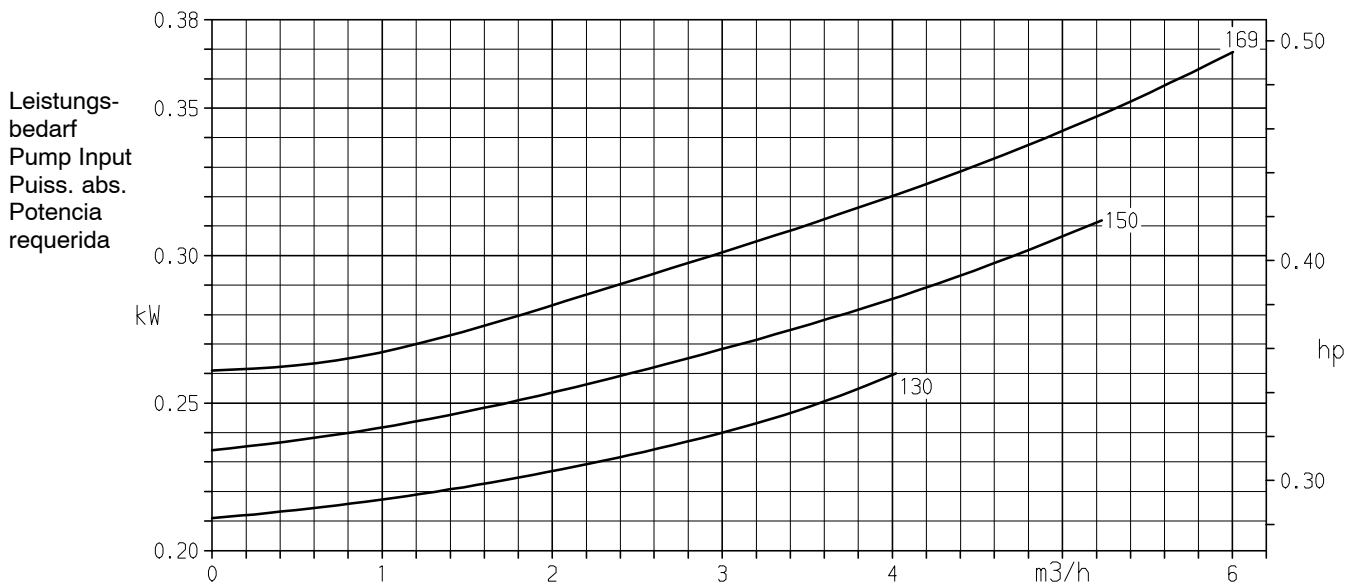
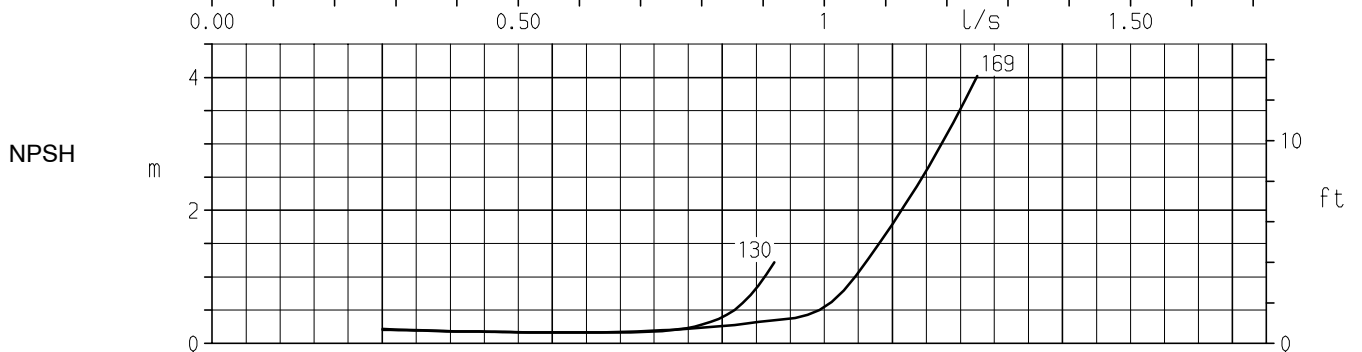
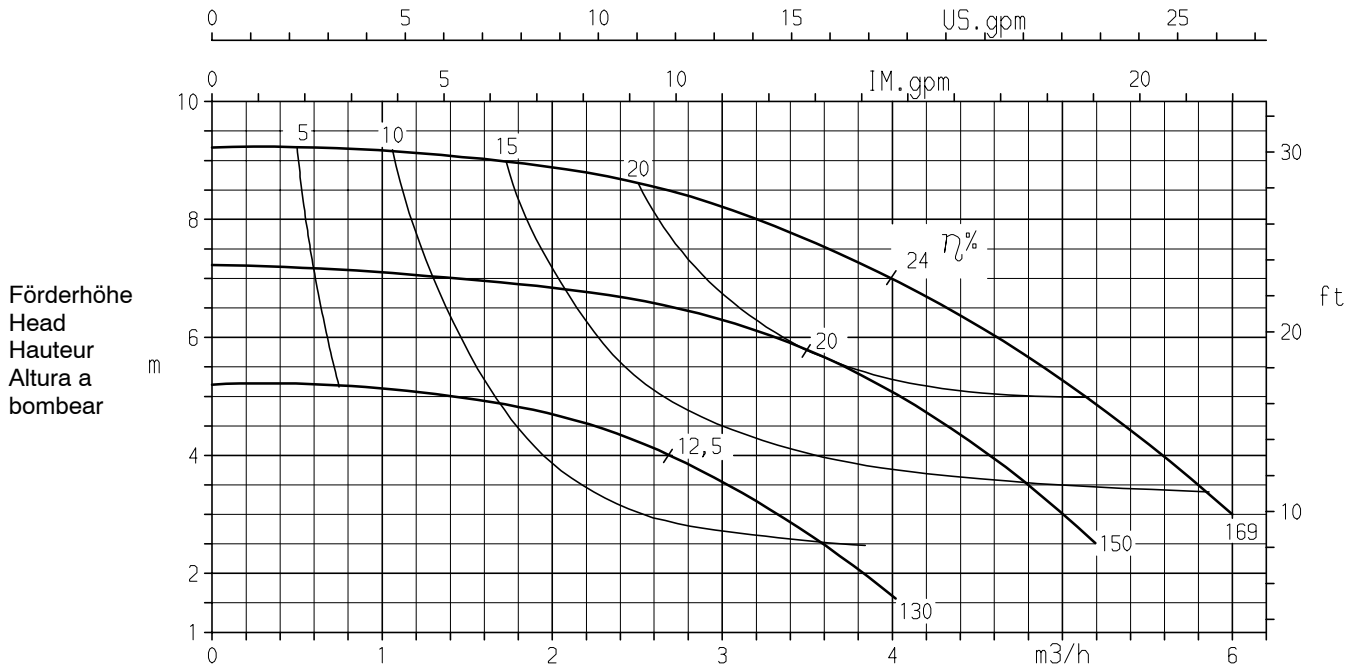



Laufradaustrittsbreite/Impeller outlet width 5,5 mm 5,5 mm
 Largeur à la sortie de la roue/Anchura de salida del rodete

Förderstrom/Capacity/Débit/Caudal

K 34 010

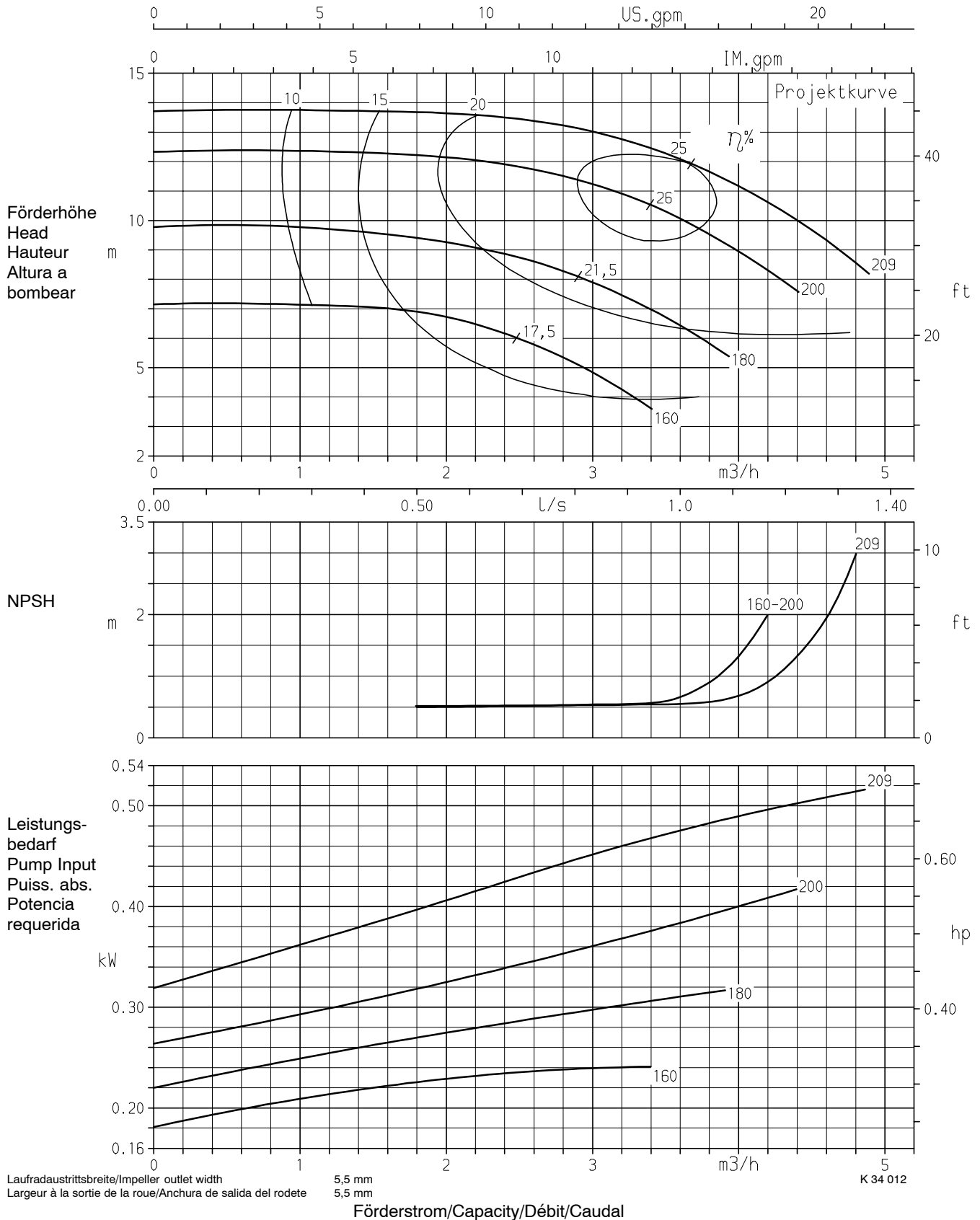
Baureihe Pump type	Modèle Tipo	Nenn Drehzahl Nom. speed	Vitesse nom. Revoluciones nom.	 KSB KSB Aktiengesellschaft Industrie- und Wassertechnik Postfach 1361, 91253 Pegnitz Bahnhofplatz 1, 91257 Pegnitz
CPKO	25-200	1450 1/min		
Angebots-Nr. Project No.	No. de l'offre Oferta-No.	Pos.-Nr. Item No.	No. de pos. No. de pos.	



Baureihe Pump type	Modèle Tipo	Nennzahl Nom. speed	Vitesse nom. Revoluciones nom.	 KSB KSB Aktiengesellschaft Industrie- und Wassertechnik Postfach 1361, 91253 Pegnitz Bahnhofplatz 1, 91257 Pegnitz
CPKO	32-125	1450 1/min		
Angebots-Nr. Project No.	No. de l'offre Oferta-No.	Pos.-Nr. Item No.	No. de pos. No. de pos.	

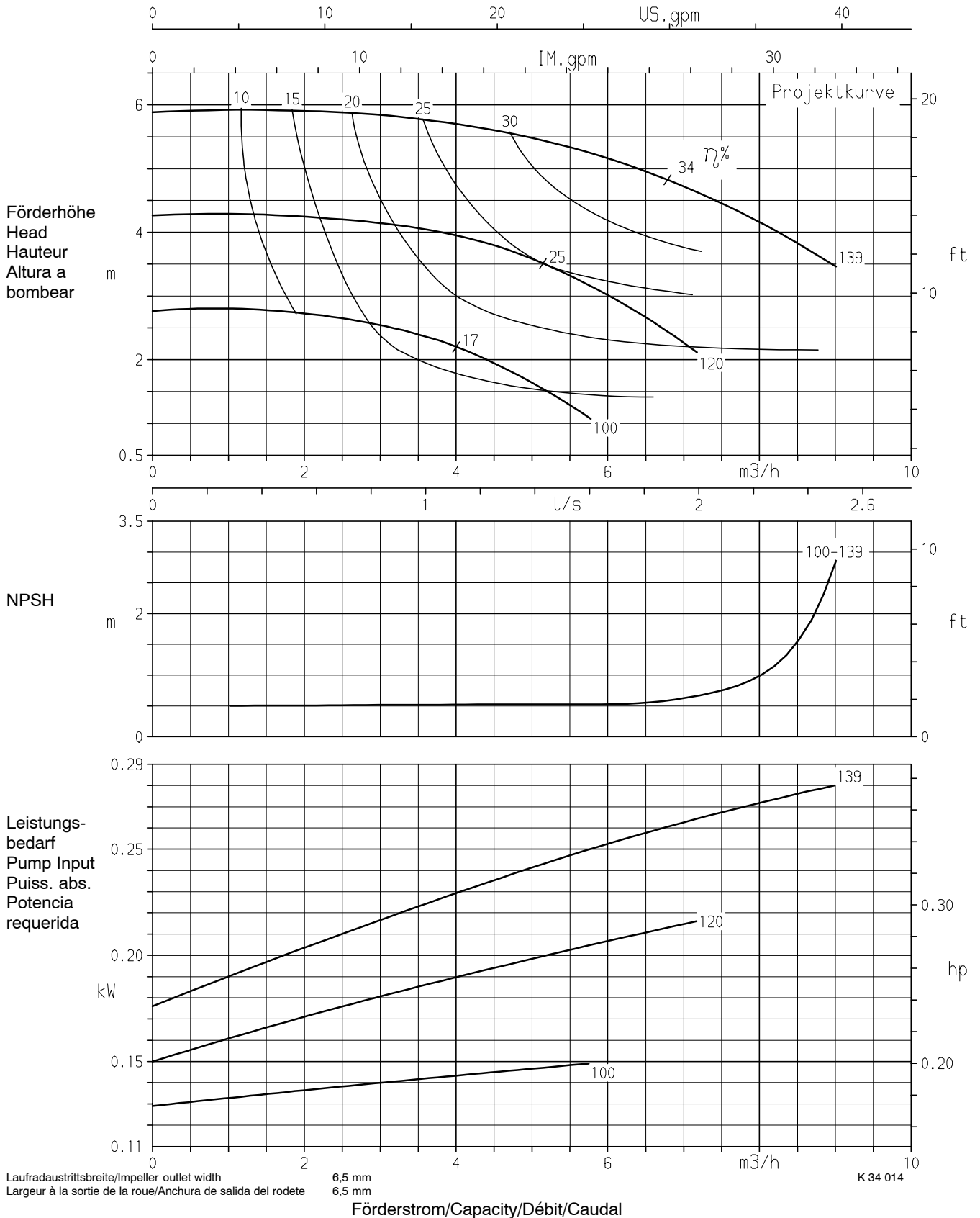

Baureihe Pump type	Modèle Tipo	Nenn Drehzahl Nom. speed	Vitesse nom. Revoluciones nom.	 KSB KSB Aktiengesellschaft Industrie- und Wassertechnik Postfach 1361, 91253 Pegnitz Bahnhofplatz 1, 91257 Pegnitz
CPKO	32-160	1450 1/min		
Angebots-Nr. Project No.	No. de l'offre Oferta-No.	Pos.-Nr. Item No.	No. de pos. No. de pos.	

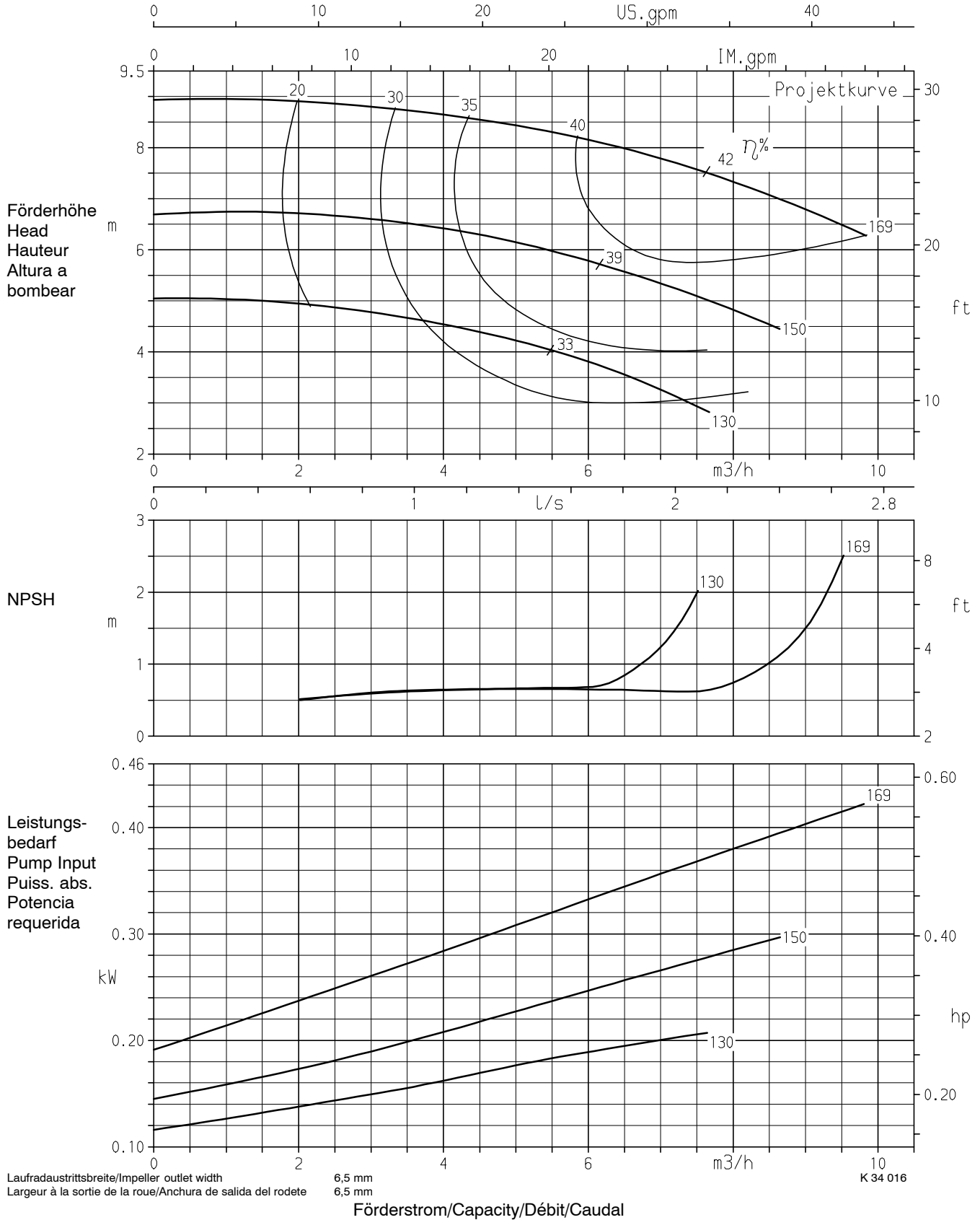

Baureihe Pump type	Modèle Tipo	Nenn Drehzahl Nom. speed	Vitesse nom. Revoluciones nom.	 KSB KSB Aktiengesellschaft Industrie- und Wassertechnik Postfach 1361, 91253 Pegnitz Bahnhofplatz 1, 91257 Pegnitz
CPKO	32-200	1450 1/min		
Angebots-Nr. Project No.	No. de l'offre Oferta-No.	Pos.-Nr. Item No.	No. de pos. No. de pos.	

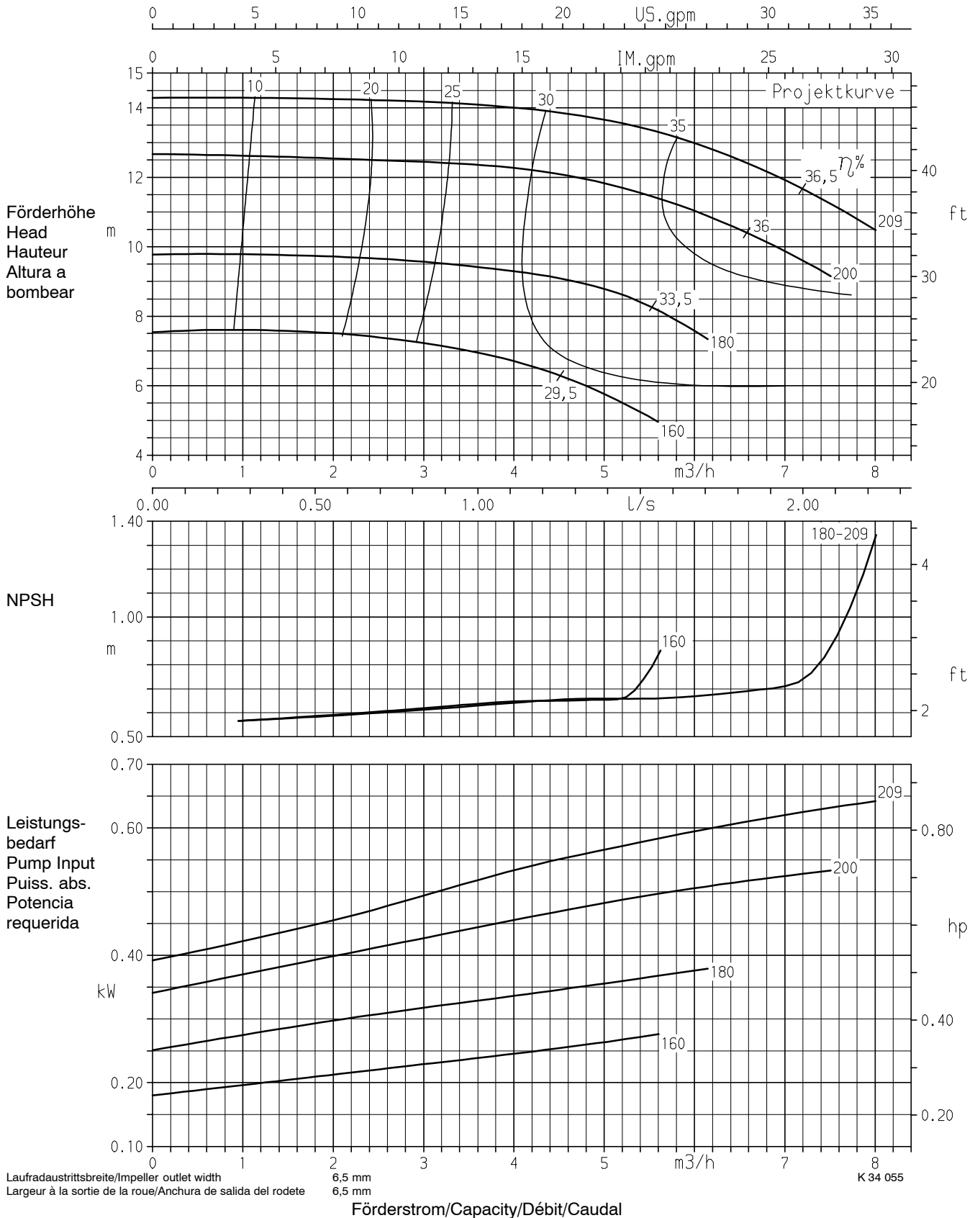

Baureihe Pump type	Modèle Tipo	Nenn Drehzahl Nom. speed	Vitesse nom. Revoluciones nom.	 KSB KSB Aktiengesellschaft Industrie- und Wassertechnik Postfach 1361, 91253 Pegnitz Bahnhofplatz 1, 91257 Pegnitz
CPKO	32-250	1450 1/min		
Angebots-Nr. Project No.	No. de l'offre Oferta-No.	Pos.-Nr. Item No.	No. de pos. No. de pos.	

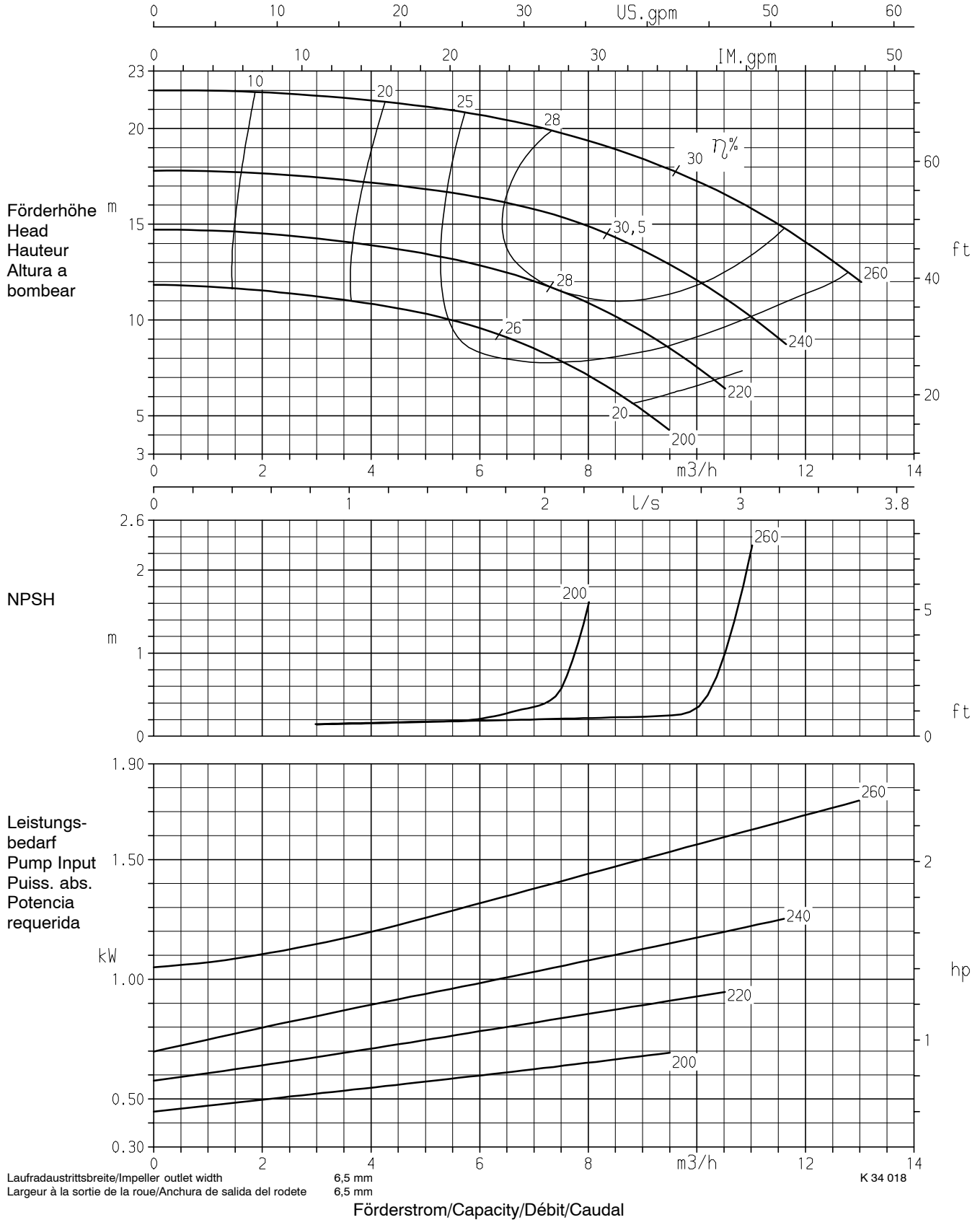

Baureihe Pump type	Modèle Tipo	Nennzahl Nom. speed	Vitesse nom. Revoluciones nom.	 KSB
CPKO	40-160	1450 1/min		
Angebots-Nr. Project No.	No. de l'offre Oferta-No.	Pos.-Nr. Item No.	No. de pos. No. de pos.	KSB Aktiengesellschaft Industrie- und Wassertechnik Postfach 1361, 91253 Pegnitz Bahnhofplatz 1, 91257 Pegnitz

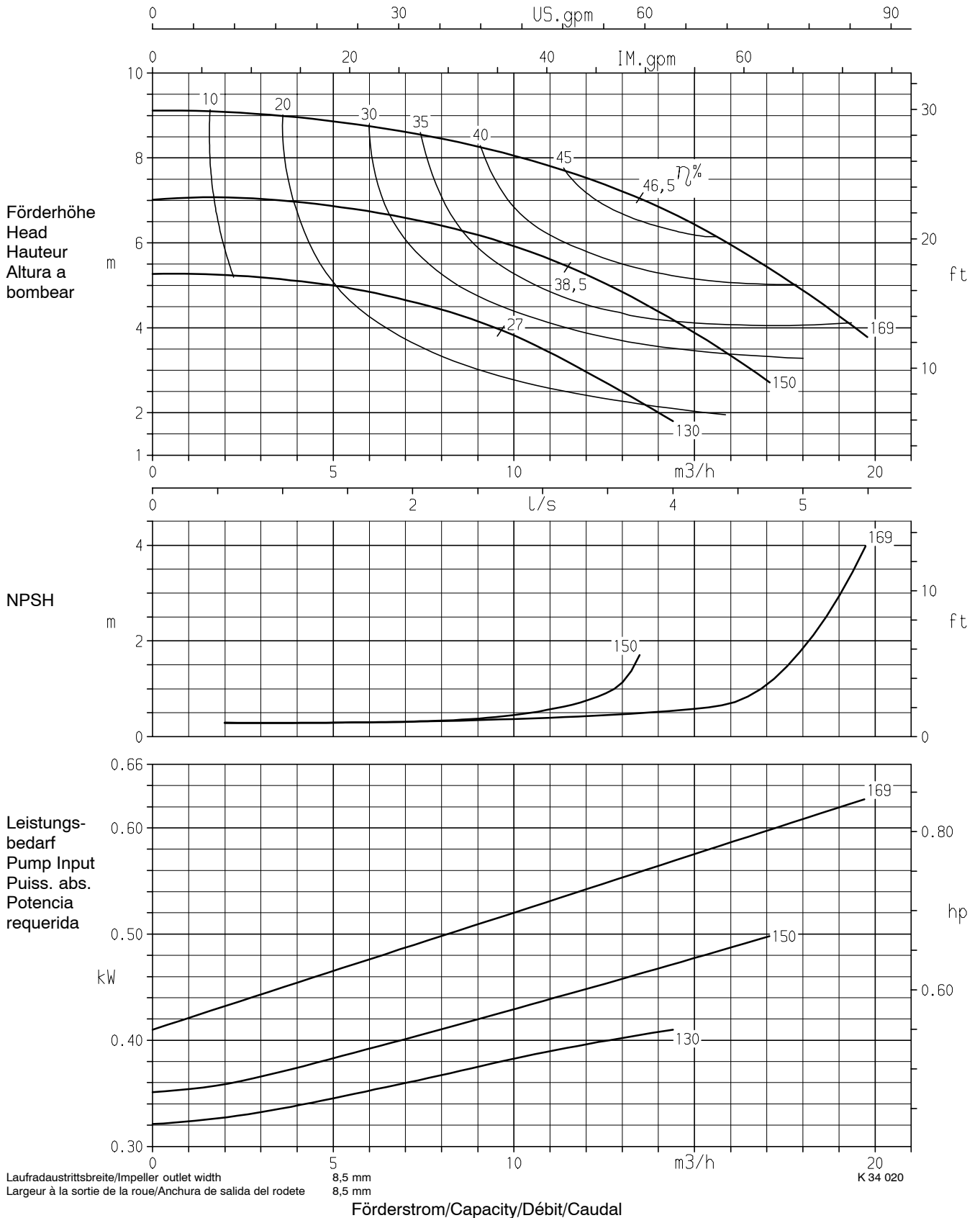

Baureihe Pump type	Modèle Tipo	Nenn Drehzahl Nom. speed	Vitesse nom. Revoluciones nom.	 KSB KSB Aktiengesellschaft Industrie- und Wassertechnik Postfach 1361, 91253 Pegnitz Bahnhofplatz 1, 91257 Pegnitz
CPKO	40-200	1450 1/min		
Angebots-Nr. Project No.	No. de l'offre Oferta-No.	Pos.-Nr. Item No.	No. de pos. No. de pos.	

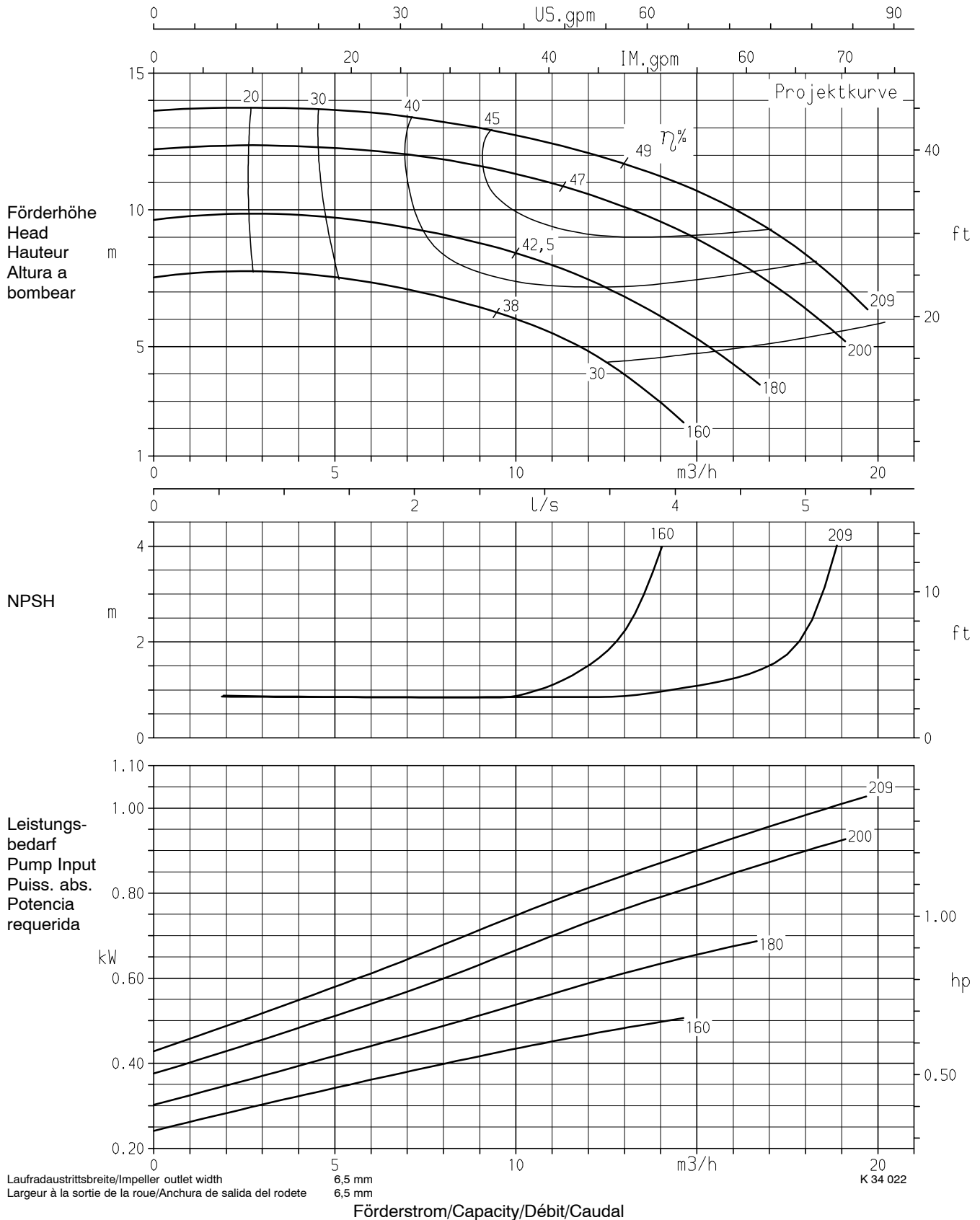

Baureihe Pump type	Modèle Tipo	Nennzahl Nom. speed	Vitesse nom. Revoluciones nom.	 KSB Aktiengesellschaft Industrie- und Wassertechnik Postfach 1361, 91253 Pegnitz Bahnhofplatz 1, 91257 Pegnitz
CPKO	40-250	1450 1/min		
Angebots-Nr. Project No.	No. de l'offre Oferta-No.	Pos.-Nr. Item No.	No. de pos. No. de pos.	

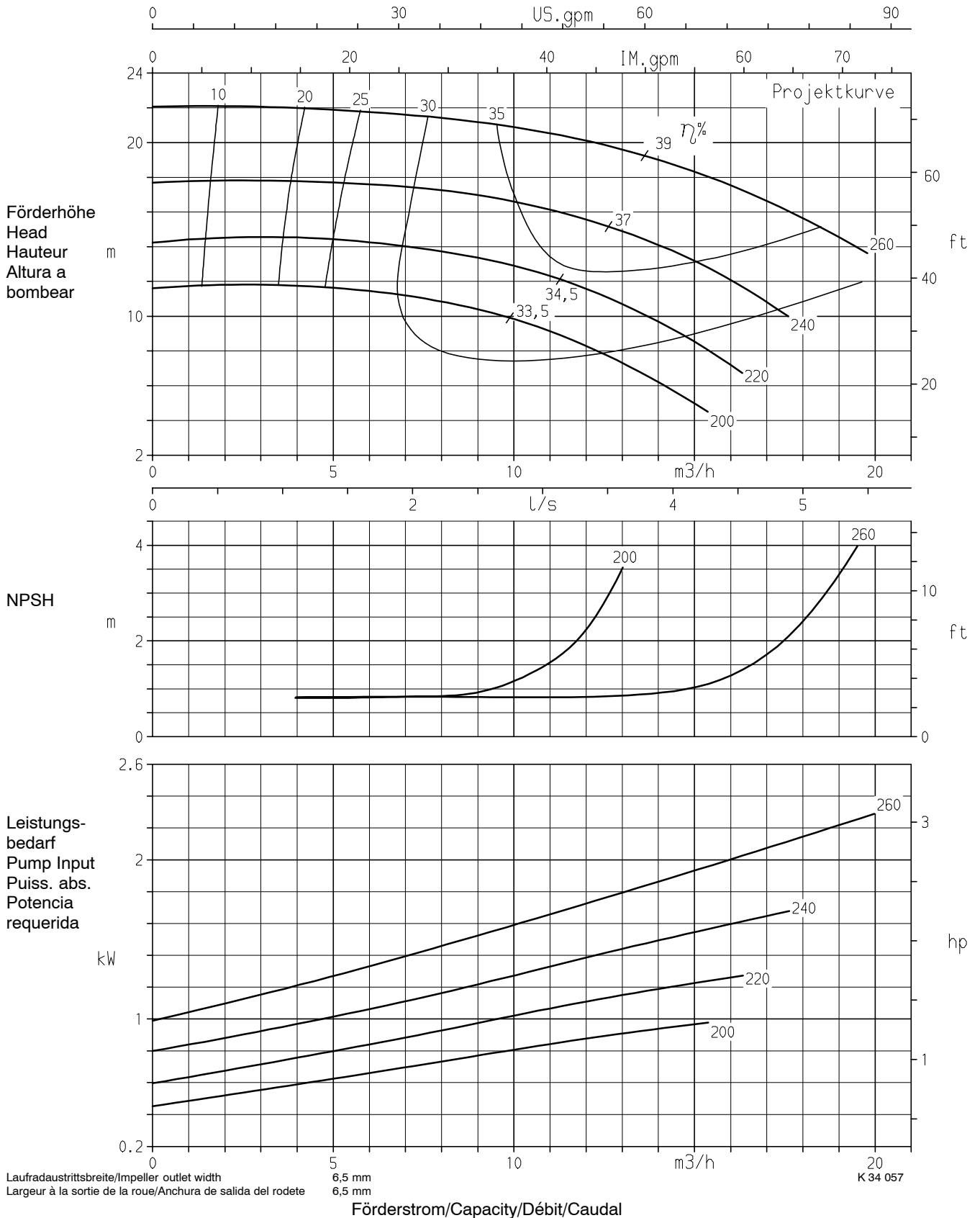

Baureihe Pump type	Modèle Tipo	Nenn Drehzahl Nom. speed	Vitesse nom. Revoluciones nom.	 KSB KSB Aktiengesellschaft Industrie- und Wassertechnik Postfach 1361, 91253 Pegnitz Bahnhofplatz 1, 91257 Pegnitz
CPKO	40-315	1450 1/min		
Angebots-Nr. Project No.	No. de l'offre Oferta-No.	Pos.-Nr. Item No.	No. de pos. No. de pos.	

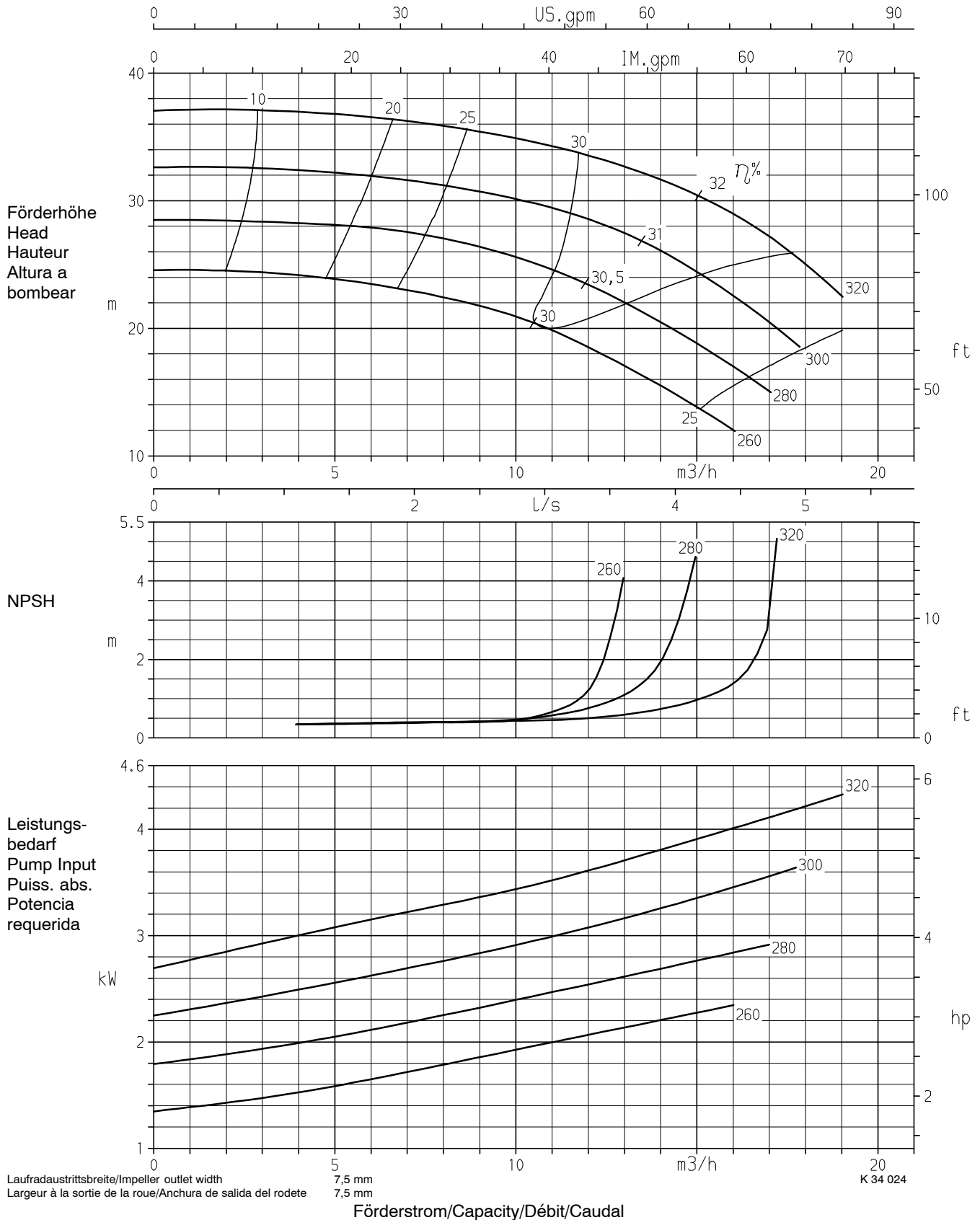

Baureihe Pump type	Modèle Tipo	Nenn Drehzahl Nom. speed	Vitesse nom. Revoluciones nom.	 KSB Aktiengesellschaft Industrie- und Wassertechnik Postfach 1361, 91253 Pegnitz Bahnhofplatz 1, 91257 Pegnitz
CPKO	50-160	1450 1/min		
Angebots-Nr. Project No.	No. de l'offre Oferta-No.	Pos.-Nr. Item No.	No. de pos. No. de pos.	

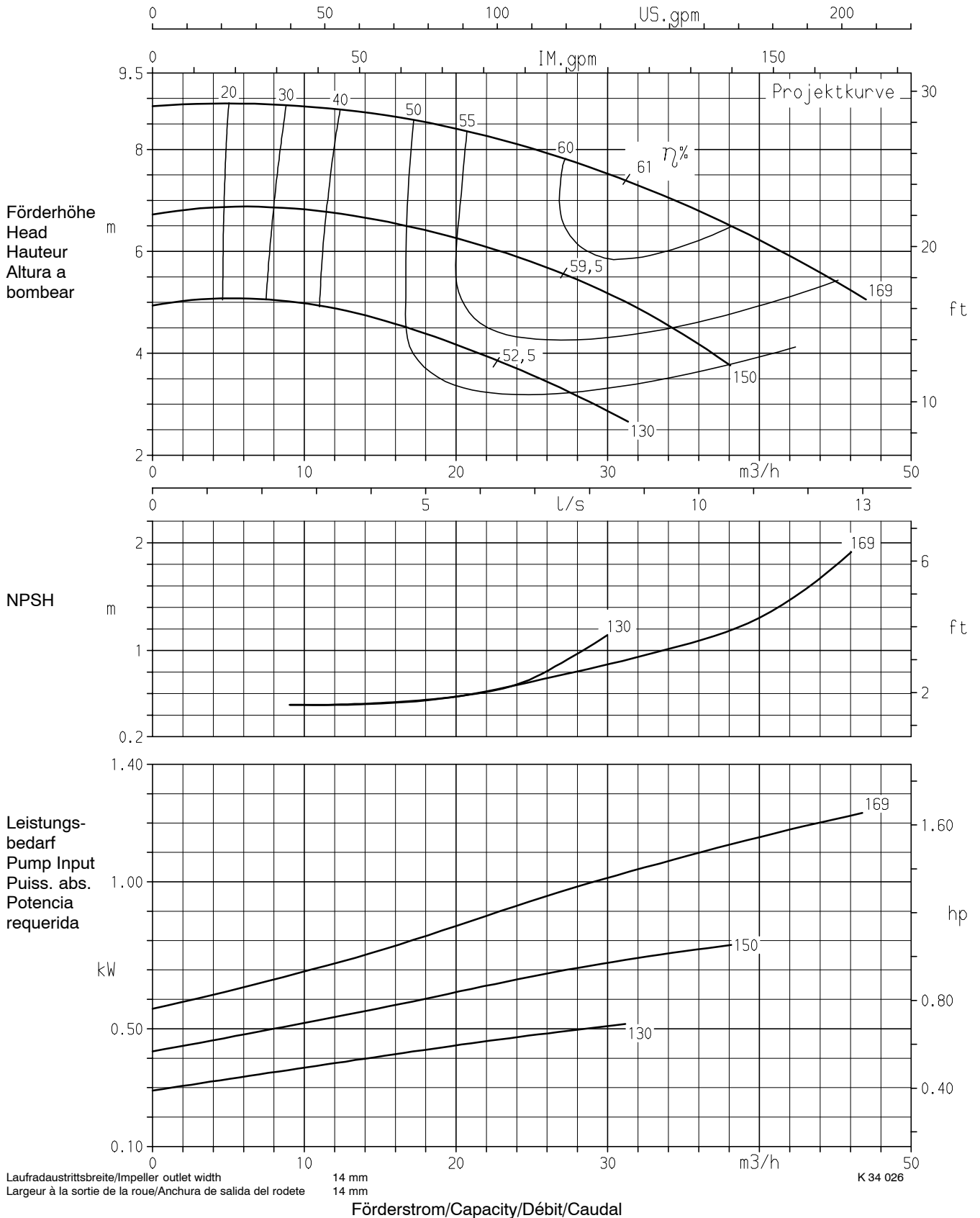

Baureihe Pump type	Modèle Tipo	Nenn Drehzahl Nom. speed	Vitesse nom. Revoluciones nom.	 KSB KSB Aktiengesellschaft Industrie- und Wassertechnik Postfach 1361, 91253 Pegnitz Bahnhofplatz 1, 91257 Pegnitz
CPKO	50-200	1450 1/min		
Angebots-Nr. Project No.	No. de l'offre Oferta-No.	Pos.-Nr. Item No.	No. de pos. No. de pos.	

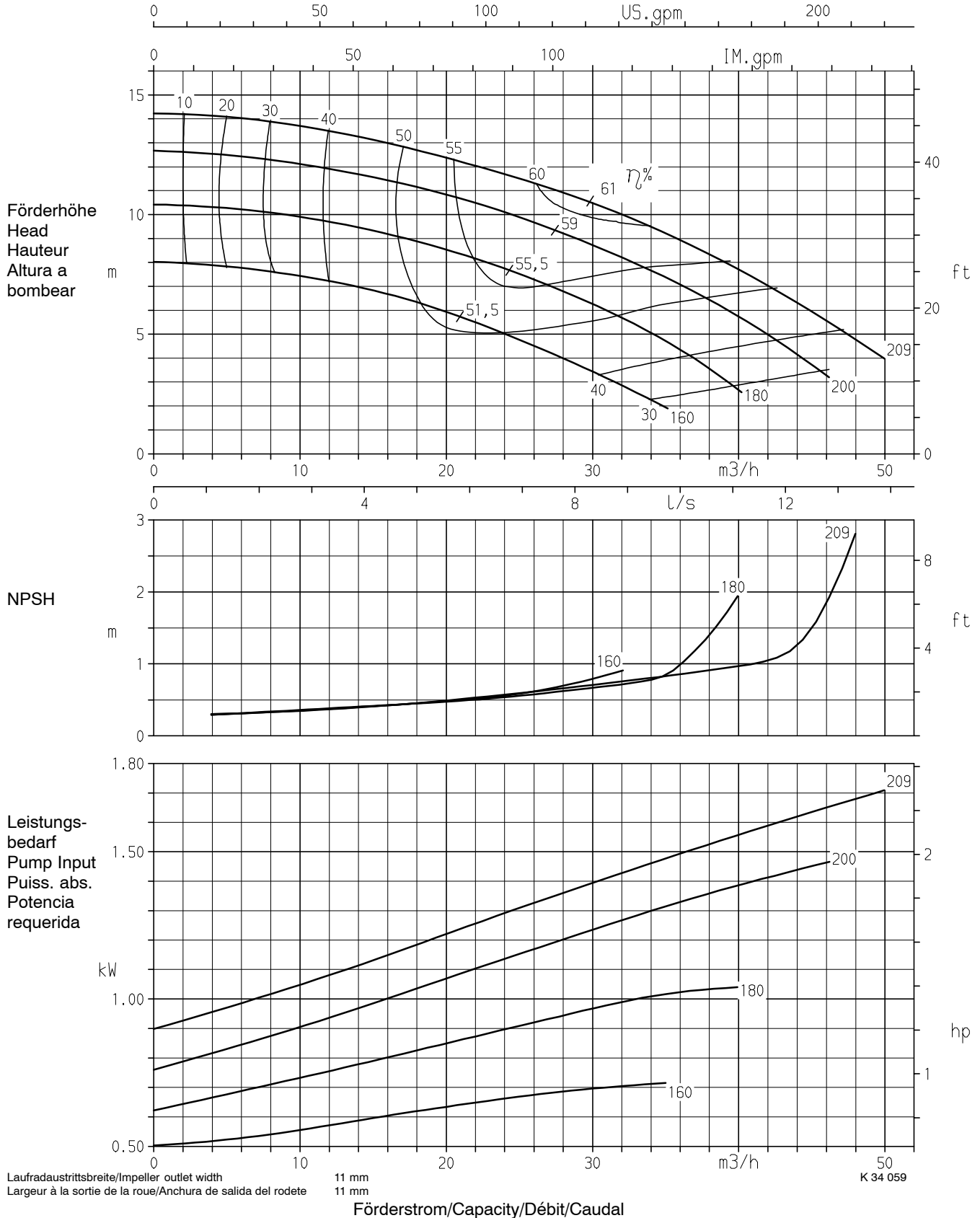

Baureihe Pump type	Modèle Tipo	Nenn Drehzahl Nom. speed	Vitesse nom. Revoluciones nom.	 <p>KSB Aktiengesellschaft Industrie- und Wassertechnik Postfach 1361, 91253 Pegnitz Bahnhofplatz 1, 91257 Pegnitz</p>
CPKO	50-250	1450 1/min		
Angebots-Nr. Project No.	No. de l'offre Oferta-No.	Pos.-Nr. Item No.	No. de pos. No. de pos.	

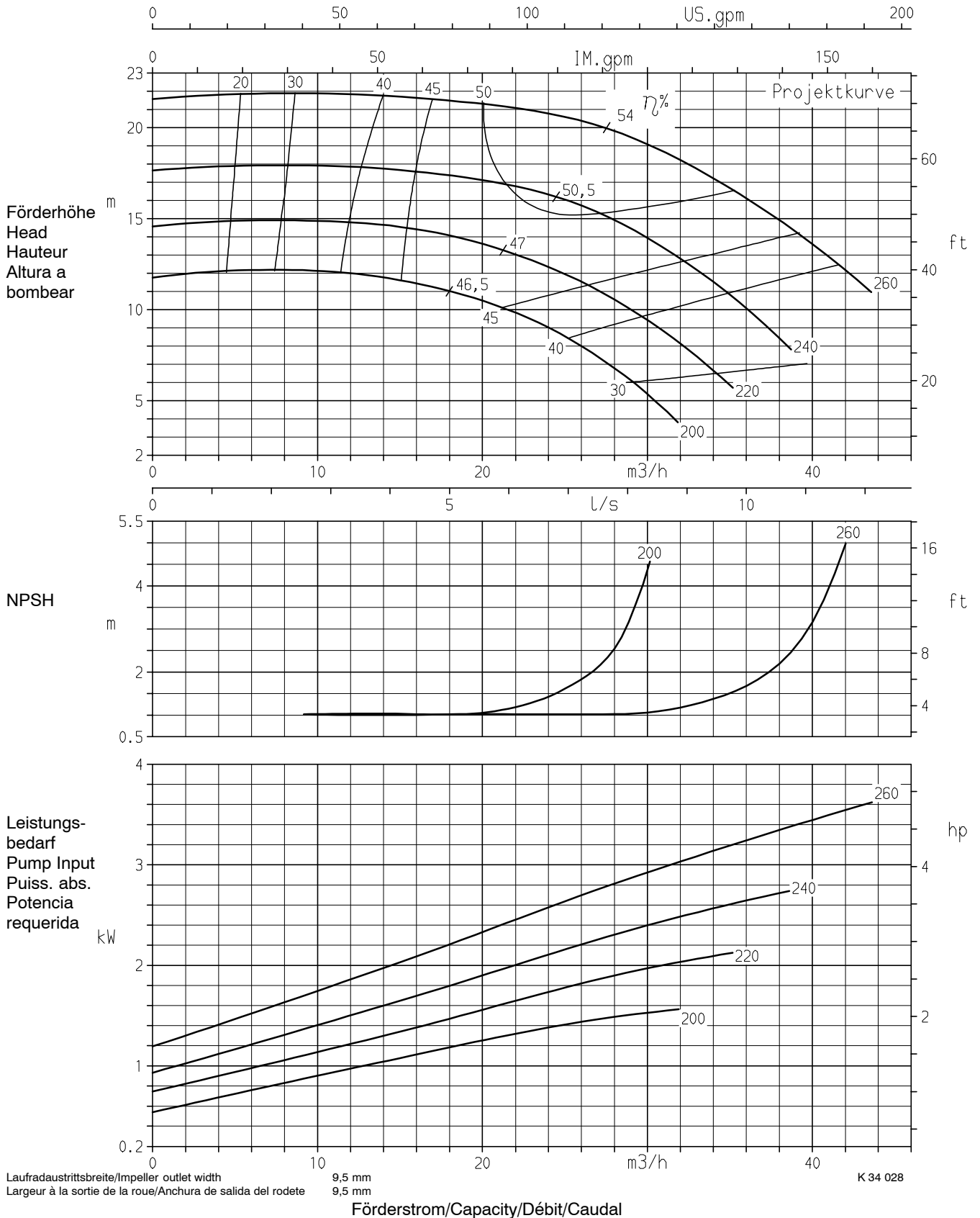

Baureihe Pump type	Modèle Tipo	Nenn Drehzahl Nom. speed	Vitesse nom. Revoluciones nom.	 KSB KSB Aktiengesellschaft Industrie- und Wassertechnik Postfach 1361, 91253 Pegnitz Bahnhofplatz 1, 91257 Pegnitz
CPKO	50-315	1450 1/min		
Angebots-Nr. Project No.	No. de l'offre Oferta-No.	Pos.-Nr. Item No.	No. de pos. No. de pos.	

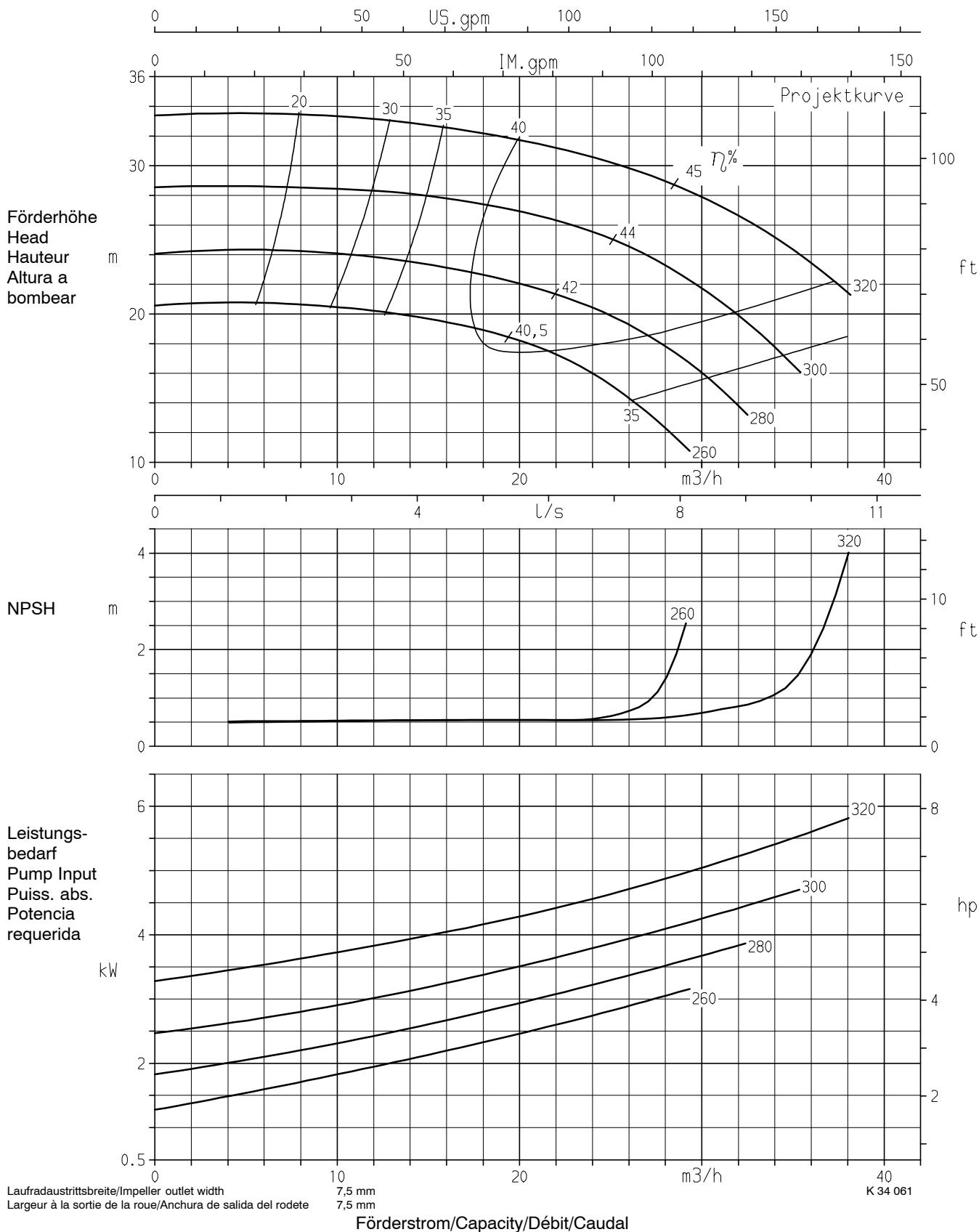

Baureihe Pump type	Modèle Tipo	Nennzahl Nom. speed	Vitesse nom. Revoluciones nom.	 KSB KSB Aktiengesellschaft Industrie- und Wassertechnik Postfach 1361, 91253 Pegnitz Bahnhofplatz 1, 91257 Pegnitz
CPKO	65-160	1450 1/min		
Angebots-Nr. Project No.	No. de l'offre Oferta-No.	Pos.-Nr. Item No.	No. de pos. No. de pos.	

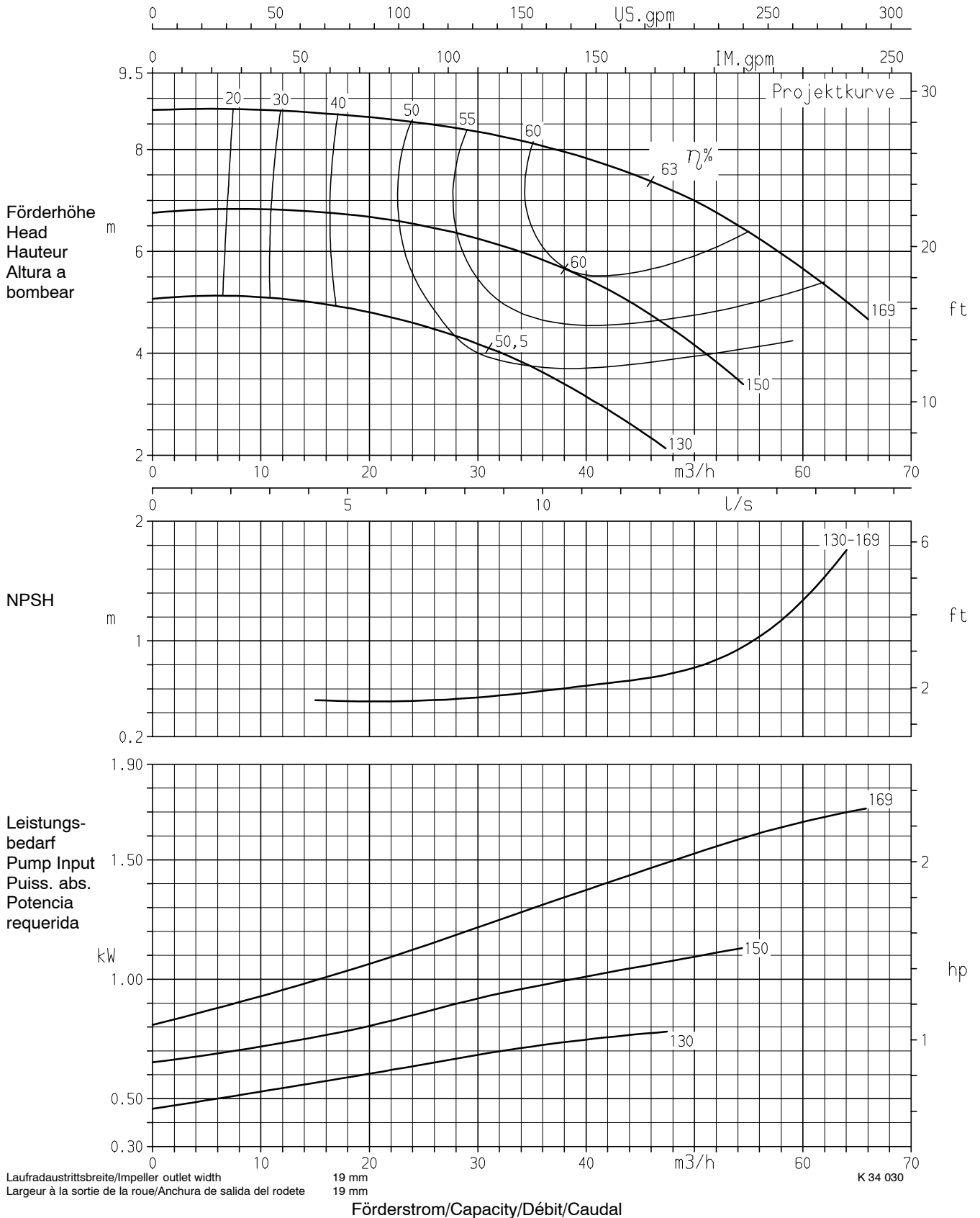

Baureihe Pump type	Modèle Tipo	Nenn Drehzahl Nom. speed	Vitesse nom. Revoluciones nom.	 KSB KSB Aktiengesellschaft Industrie- und Wassertechnik Postfach 1361, 91253 Pegnitz Bahnhofplatz 1, 91257 Pegnitz
CPKO	65-200	1450 1/min		
Angebots-Nr. Project No.	No. de l'offre Oferta-No.	Pos.-Nr. Item No.	No. de pos. No. de pos.	

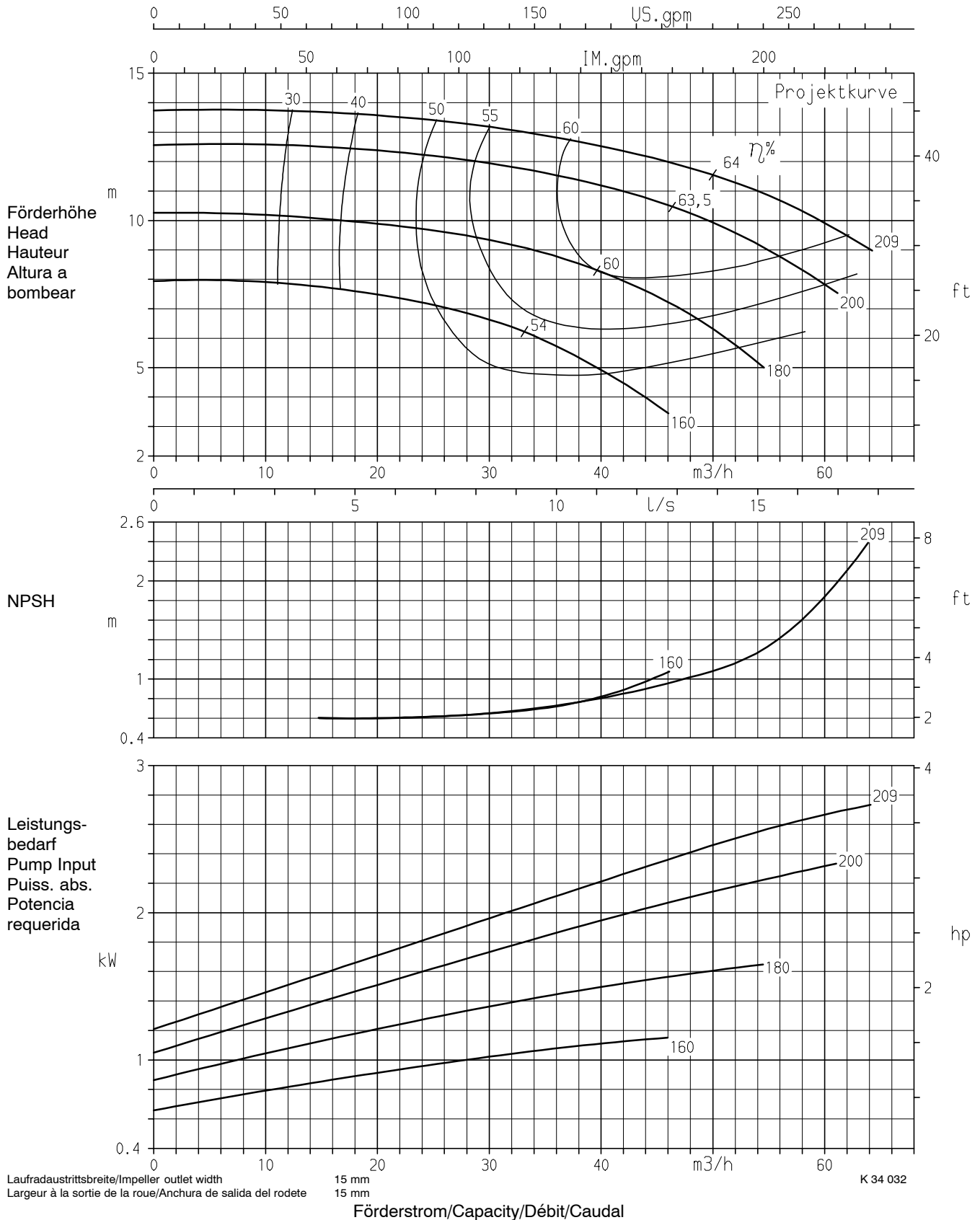

Baureihe Pump type	Modèle Tipo	Nennzahl Nom. speed	Vitesse nom. Revoluciones nom.	 KSB KSB Aktiengesellschaft Industrie- und Wassertechnik Postfach 1361, 91253 Pegnitz Bahnhofplatz 1, 91257 Pegnitz
CPKO	65-250	1450 1/min		
Angebots-Nr. Project No.	No. de l'offre Oferta-No.	Pos.-Nr. Item No.	No. de pos. No. de pos.	

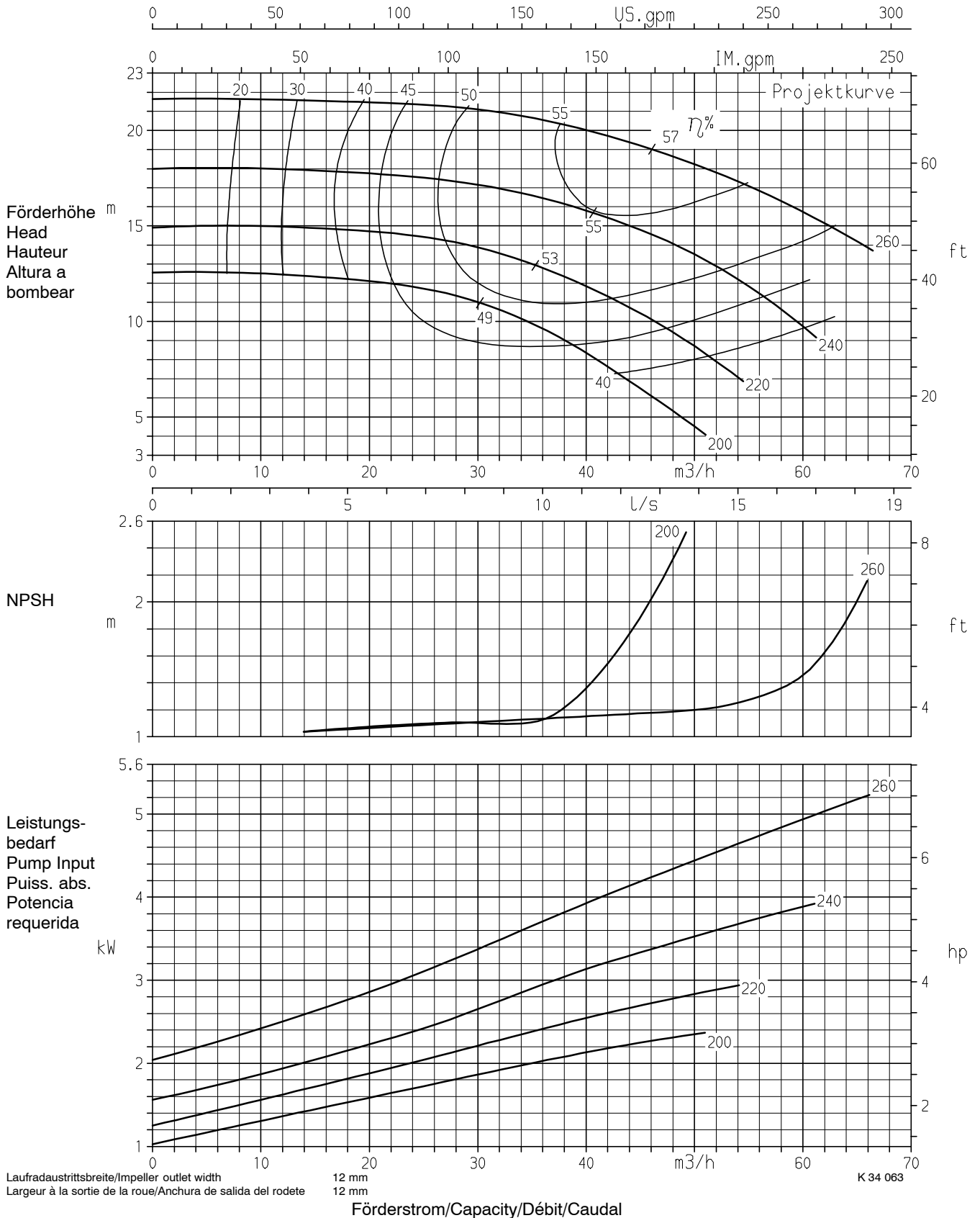

Baureihe Pump type	Modèle Tipo	Nenn Drehzahl Nom. speed	Vitesse nom. Revoluciones nom.	 KSB KSB Aktiengesellschaft Industrie- und Wassertechnik Postfach 1361, 91253 Pegnitz Bahnhofplatz 1, 91257 Pegnitz
CPKO	65-315	1450 1/min		
Angebots-Nr. Project No.	No. de l'offre Oferta-No.	Pos.-Nr. Item No.	No. de pos. No. de pos.	

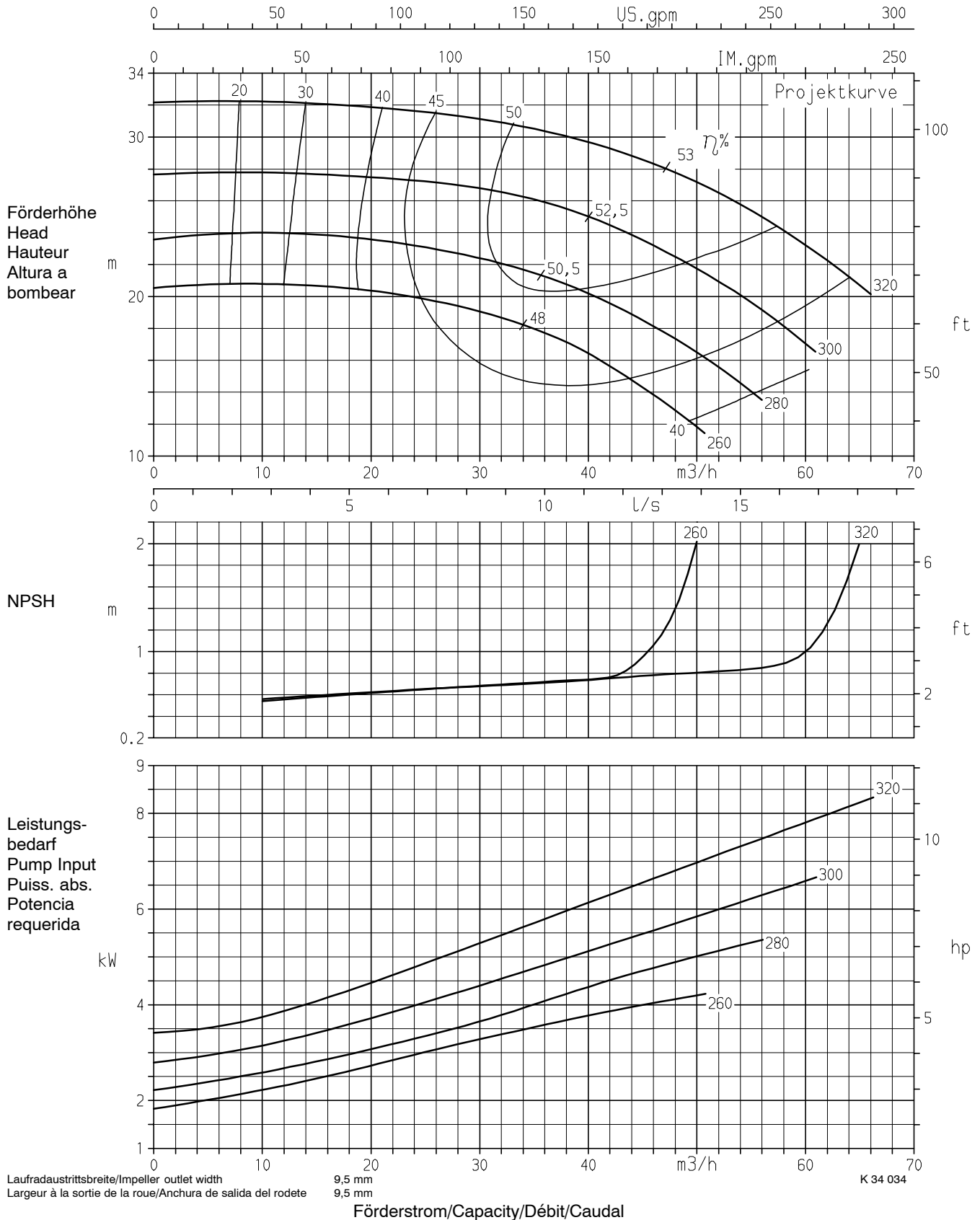

Baureihe Pump type	Modèle Tipo	Nenn Drehzahl Nom. speed	Vitesse nom. Revoluciones nom.	 KSB KSB Aktiengesellschaft Industrie- und Wassertechnik Postfach 1361, 91253 Pegnitz Bahnhofplatz 1, 91257 Pegnitz
CPKO	80-160	1450 1/min		
Angebots-Nr. Project No.	No. de l'offre Oferta-No.	Pos.-Nr. Item No.	No. de pos. No. de pos.	

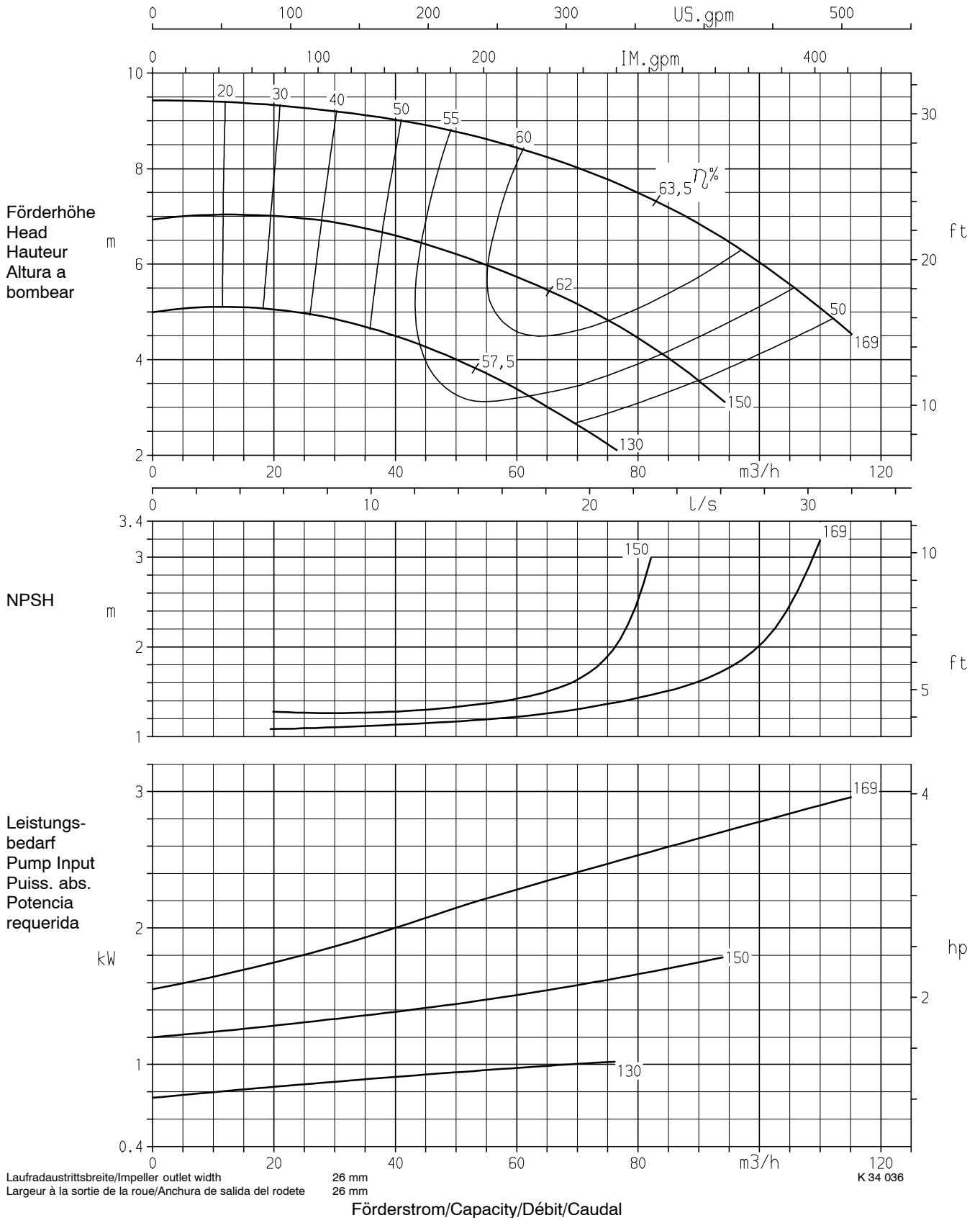

Baureihe Pump type	Modèle Tipo	Nenn Drehzahl Nom. speed	Vitesse nom. Revoluciones nom.	 KSB KSB Aktiengesellschaft Industrie- und Wassertechnik Postfach 1361, 91253 Pegnitz Bahnhofplatz 1, 91257 Pegnitz
CPKO	80-200	1450 1/min		
Angebots-Nr. Project No.	No. de l'offre Oferta-No.	Pos.-Nr. Item No.	No. de pos. No. de pos.	

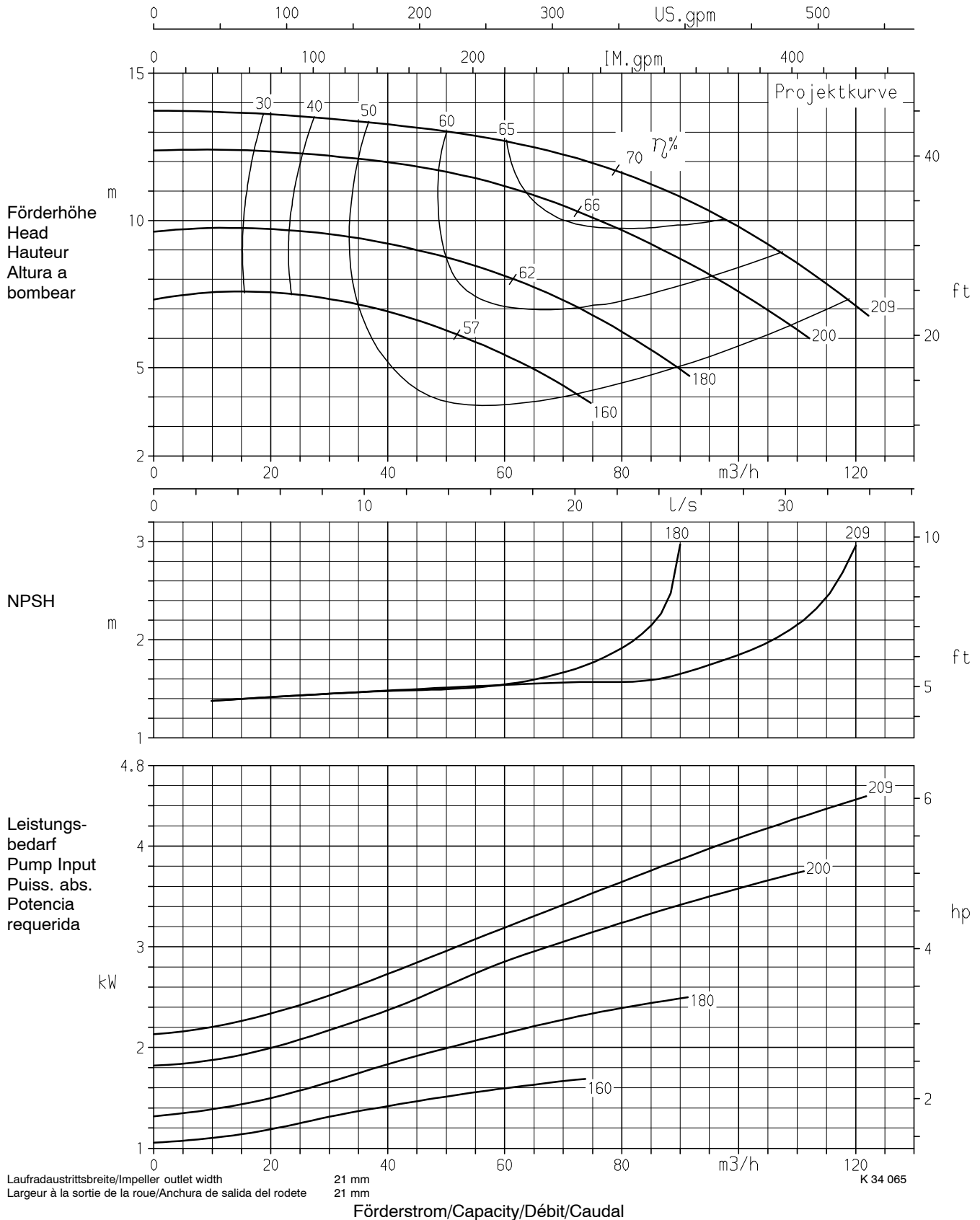

Baureihe Pump type	Modèle Tipo	Nenn Drehzahl Nom. speed	Vitesse nom. Revoluciones nom.	 <p>KSB Aktiengesellschaft Industrie- und Wassertechnik Postfach 1361, 91253 Pegnitz Bahnhofplatz 1, 91257 Pegnitz</p>
CPKO	80-250	1450 1/min		
Angebots-Nr. Project No.	No. de l'offre Oferta-No.	Pos.-Nr. Item No.	No. de pos. No. de pos.	

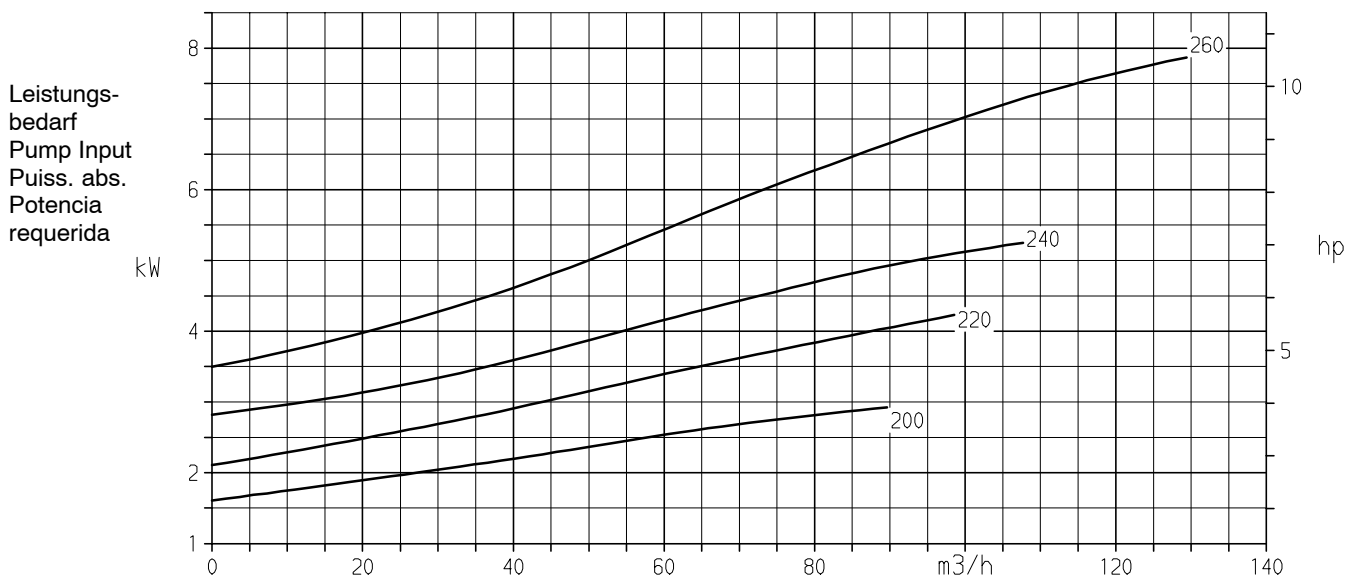
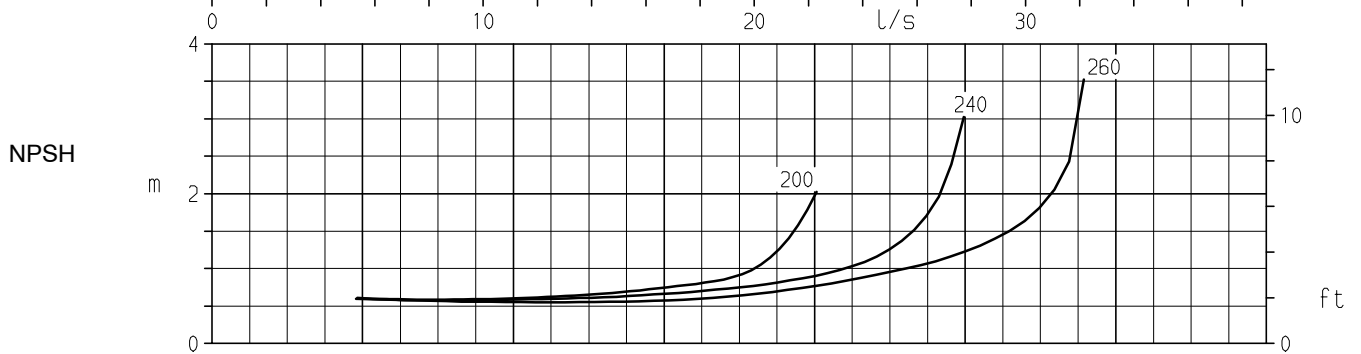
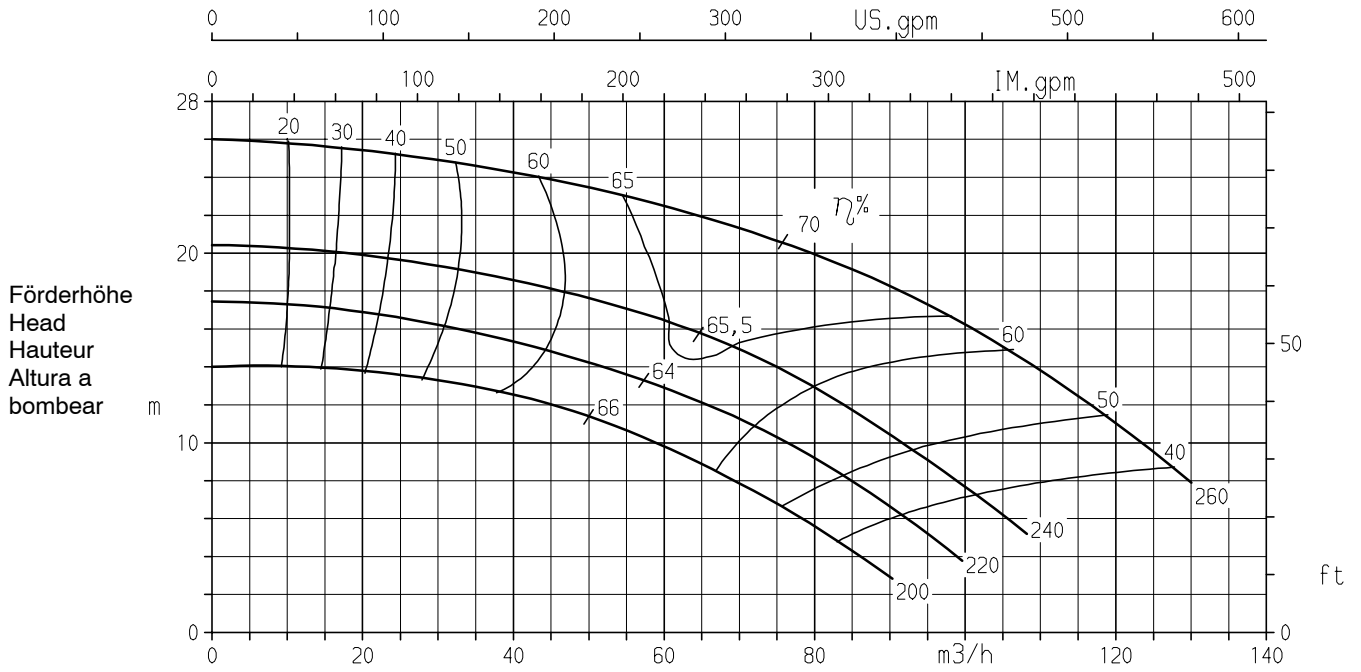

Laufadaustrittsbreite/Impeller outlet width
Largeur à la sortie de la roue/Anchura de salida del rodete

16 mm
16 mm

Förderstrom/Capacity/Débit/Caudal

K 34 038

Baureihe Pump type	Modèle Tipo	Nenn Drehzahl Nom. speed	Vitesse nom. Revoluciones nom.	 KSB KSB Aktiengesellschaft Industrie- und Wassertechnik Postfach 1361, 91253 Pegnitz Bahnhofplatz 1, 91257 Pegnitz
CPKO	80-315	1450 1/min		
Angebots-Nr. Project No.	No. de l'offre Oferta-No.	Pos.-Nr. Item No.	No. de pos. No. de pos.	

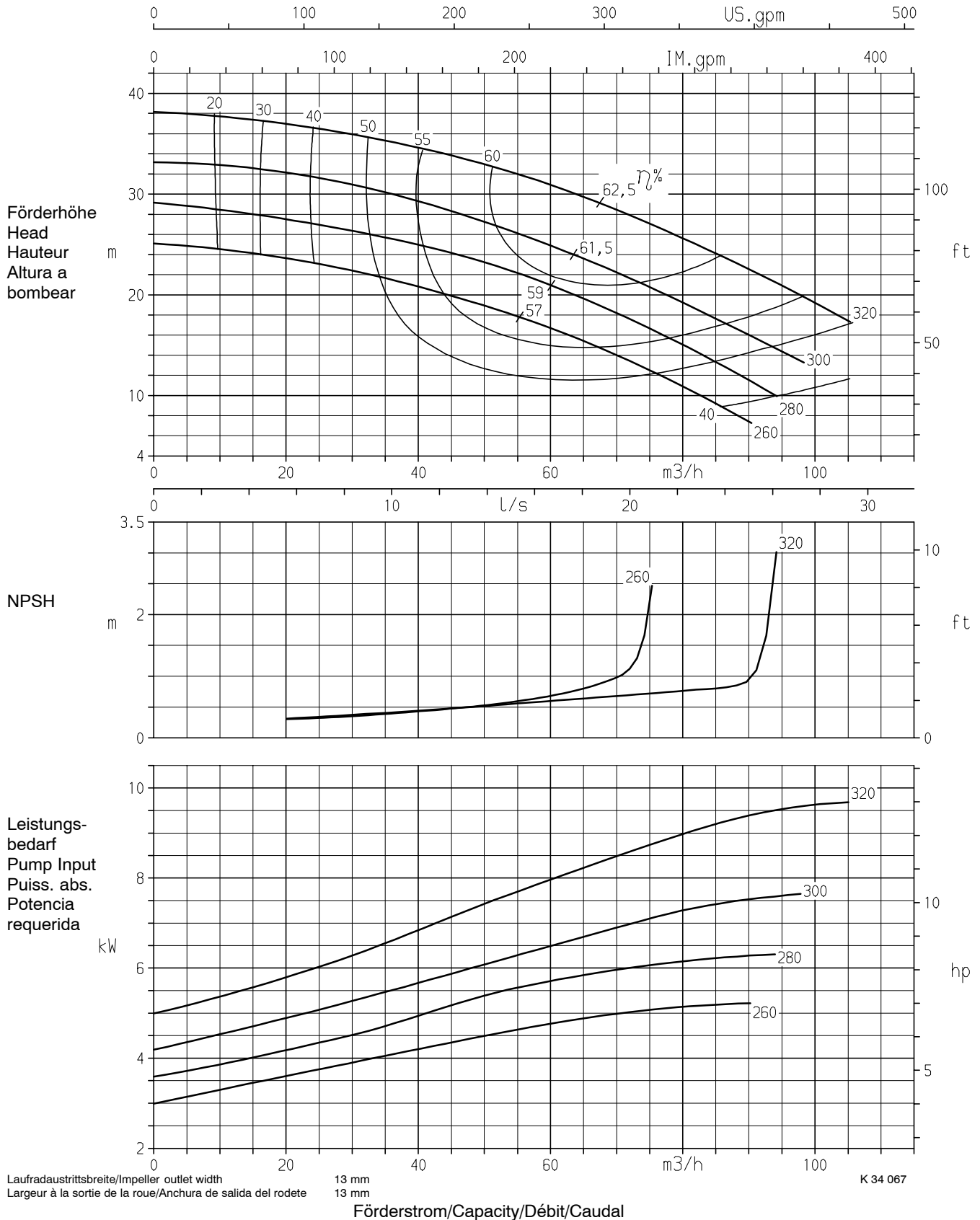

Baureihe Pump type	Modèle Tipo	Nenn Drehzahl Nom. speed	Vitesse nom. Revoluciones nom.	 KSB KSB Aktiengesellschaft Industrie- und Wassertechnik Postfach 1361, 91253 Pegnitz Bahnhofplatz 1, 91257 Pegnitz
CPKO	80-400	1450 1/min		
Angebots-Nr. Project No.	No. de l'offre Oferta-No.	Pos.-Nr. Item No.	No. de pos. No. de pos.	

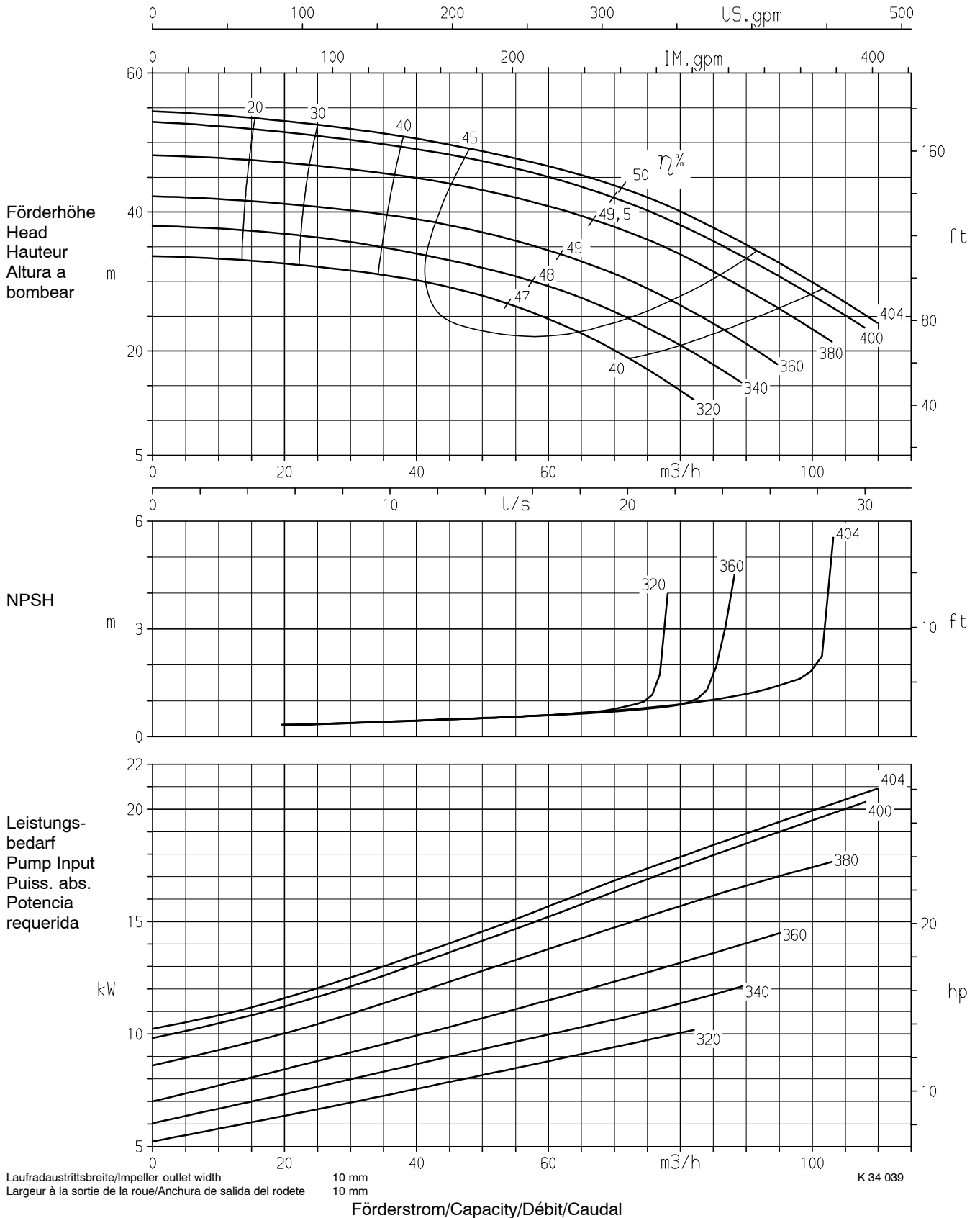

Baureihe Pump type	Modèle Tipo	Nenn Drehzahl Nom. speed	Vitesse nom. Revoluciones nom.	 KSB KSB Aktiengesellschaft Industrie- und Wassertechnik Postfach 1361, 91253 Pegnitz Bahnhofplatz 1, 91257 Pegnitz
CPKO	100-200	1450 1/min		
Angebots-Nr. Project No.	No. de l'offre Oferta-No.	Pos.-Nr. Item No.	No. de pos. No. de pos.	

